

Fully aligned
with the Australian
Curriculum

The
PrimaryConnections
program is supported by
astronomer, Professor
Brian Schmidt,
2011 Nobel Laureate

Essential energy

Year 6

Physical sciences

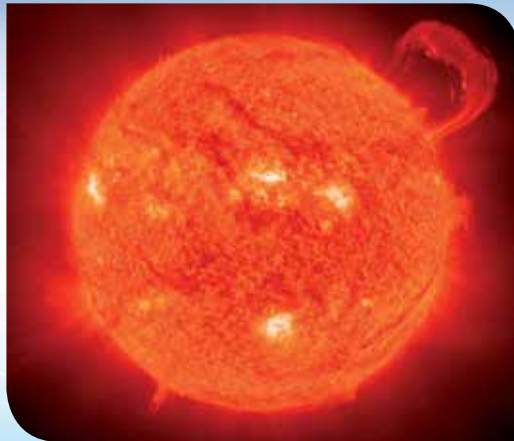

PrimaryConnections project

Director	Ms Shelley Peers (Australian Academy of Science)
Reference Group	Professor Jenny Graves, AO FAA (Australian Academy of Science) [Chair] Ms Shelley Peers (Australian Academy of Science) ACT Department of Education and Training Australian Council of Deans of Education Australian Curriculum Assessment and Reporting Authority (ACARA) Australian Government Department of Education, Employment and Workplace Relations Australian Literacy Educators' Association Australian Primary Principals Association Australian Science Teachers Association QLD Department of Education, Training and Employment Independent Schools Council of Australia Indigenous Education Consultative Body National Catholic Education Commission NSW Department of Education and Communities NT Department of Education and Training Primary English Teaching Association Australia SA Department for Education and Child Development TAS Department of Education VIC Department of Education and Early Childhood Development WA Department of Education



Australian Government



Australian Academy of Science

Professional learning program

The Primary**Connections** program includes a sophisticated professional learning component and exemplary curriculum resources. Research shows that this combination is more effective than using each in isolation.

Professional Learning Facilitators are available throughout Australia to conduct workshops on the underpinning principles of the program: the Primary**Connections** 5Es teaching and learning model, linking science with literacy, investigating, embedded assessment and collaborative learning.

The Primary**Connections** website has contact details for state and territory Professional Learning Coordinators, as well as additional resources for this unit. Visit the website at:

www.science.org.au/primaryconnections

Fully aligned
with the Australian
Curriculum

Essential energy

Year 6

Physical sciences

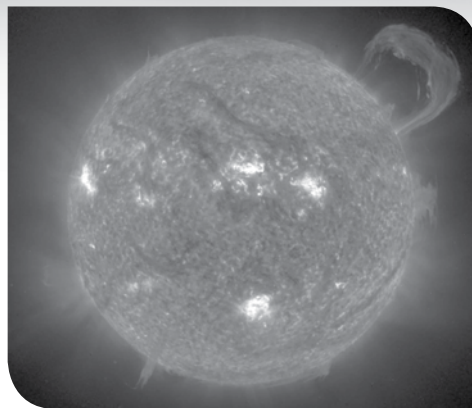

Every day we use energy to make changes to our surroundings. We heat rooms, freeze food and communicate using light, sound and electricity. Power stations and local solutions such as batteries provide us with electrical energy that machines transform into the useful energies that we require. However, we cannot create energy; we can only transform energy already present in our environment. So where does this electrical energy come from? There are many different ways that we use the Earth's resources to generate the energies we desire.

The *Essential energy* unit is an ideal way to link science with literacy in the classroom. It provides opportunities for students to explore how energy is used to make changes in their world, including energy from the Sun, water and wind. Students' understanding of how to improve the efficiency of a waterwheel is developed through hands-on activities and student-planned investigations. Students also investigate variables that affect the output of a simple battery made from household items.



Australian Government



Australian Academy of Science

Published by the Australian Academy of Science.

GPO Box 783
Canberra ACT 2601
Telephone: (02) 9386 4544
Fax: (02) 9387 7755
Email: pc@science.org.au
www.science.org.au/primaryconnections

© Australian Academy of Science, January 2012.

Reproduction and communication for educational purposes

The *Australian Copyright Act 1968* allows a maximum of one chapter or 10% of the pages of this work, whichever is the greater, to be reproduced and/or communicated by any educational institution for its educational purposes. Requests and enquiries for further authorisation should be addressed to the Australian Academy of Science. You may also view the Australian Academy of Science Education Use Licence at www.science.org.au

Font: Helvetica Neue, DIN
Cover images: Wikimedia Commons, iStockphoto.com

ISBN 978 0 85847 303 4

Acknowledgments

PrimaryConnections is supported by the Australian Government.

Thanks to the trial teachers and students of the trial schools Australia-wide and Fellows of the Australian Academy of Science who contributed to this unit.

All material identified by  is material subject to copyright under the Copyright Act 1968 (Cth) and is owned by the Australian Curriculum, Assessment and Reporting Authority 2012.

For all Australian Curriculum material except elaborations: This is an extract from the Australian Curriculum.

Elaborations: This may be a modified extract from the Australian Curriculum and may include the work of other authors.

Disclaimer: ACARA neither endorses nor verifies the accuracy of the information provided and accepts no responsibility for incomplete or inaccurate information. In particular, ACARA does not endorse or verify that:

- The content descriptions are solely for a particular year and subject;
- All the content descriptions for that year and subject have been used; and
- The author's material aligns with the Australian Curriculum content descriptions for the relevant year and subject.

You can find the unaltered and most up to date version of this material at <http://www.australiancurriculum.edu.au>
This material is reproduced with the permission of ACARA.

Disclaimers

The views expressed herein do not necessarily represent the views of the Australian Government Department of Education, Employment and Workplace Relations.

These materials are intended for education and training only. Every effort is made to ensure the accuracy of the information presented in these materials. We do not assume any liability for the accuracy or completeness of the information contained within. The Australian Academy of Science accepts no liability or responsibility for any loss or damage whatsoever suffered as a result of direct or indirect use or application of any of these training materials.

Contents

The Primary Connections program	v
Unit at a glance	1
Alignment with the Australian Curriculum: Science	2
Alignment with the Australian Curriculum: English and Mathematics	7
Introduction to energy	8
Lesson ① Scientific support	11
Lesson ② Susceptible to shortages	17
Lesson ③ Here comes the Sun	30
Lesson ④ Mobilising movement	37
Lesson ⑤ Domestic help	50
Lesson ⑥ Necessary energy	59
Lesson ⑦ Full of potential	63
Lesson ⑧ Community choices	73
Appendix 1 How to organise collaborative learning teams	82
Appendix 2 How to use a science journal	86
Appendix 3 How to use a word wall	88
Appendix 4 How to use a glossary	90
Appendix 5 How to facilitate evidence-based discussions	91
Appendix 6 How to conduct a fair test	93
Appendix 7 How to write questions for investigation	95
Appendix 8 How to construct and use a graph	97
Appendix 9 <i>Essential energy</i> equipment list	99
Appendix 10 <i>Essential energy</i> unit overview	102

Foreword

The Australian Academy of Science is proud of its long tradition of supporting and informing science education in Australia. 'PrimaryConnections: linking science with literacy' is its flagship primary school science program, and it is making a real difference to the teaching and learning of science in Australian schools.

The PrimaryConnections approach has been embraced by schools since its inception in 2004, and there is substantial evidence of its effectiveness in helping teachers transform their practice. It builds teacher confidence and competence in this important area, and helps teachers use their professional skills to incorporate elements of the approach into other areas of the curriculum. Beginning and pre-service teachers find the approach do-able and sustainable. PrimaryConnections students enjoy science more than in comparison classes, and Indigenous students, in particular, show significant increases in learning using the approach.

The project has several components: professional learning, curriculum resources, research and evaluation, and Indigenous perspectives. With the development of an Australian curriculum in the sciences by ACARA in December 2010, it is an exciting time for schools to engage with science and to raise the profile of primary science education.

Students are naturally curious. PrimaryConnections provides an inquiry-based approach that helps students develop deep learning, and guides them to find scientific ways to answer their questions. The lessons include key science background information, and further science information is included on the PrimaryConnections website.

Science education provides a foundation for a scientifically literate society, which is so important for engagement in key community debates, such as climate change, carbon emissions and immunisation, as well as for personal decisions about health and well-being. The inquiry approach in PrimaryConnections prepares students well for participation in evidence-based discussions of these and other issues.

PrimaryConnections has been developed with the financial support of the Australian Government, and has been endorsed by education authorities across the country. The Steering Committee, comprising the Department of Education, Employment and Workplace Relations and Academy representatives, and the Reference Group, which includes representatives from all stakeholder bodies including states and territories, have provided invaluable guidance and support over the last seven years. Before publication, the teacher background information on science is reviewed by a Fellow of the Academy of Science. All these inputs have ensured an award-winning, quality program.

The Fellows of the Academy are committed to ongoing support for teachers of science at all levels. I commend PrimaryConnections to you and wish you well in your teaching.

Professor Suzanne Cory, AC PresAA FRS

President

Australian Academy of Science

2010–2013

The PrimaryConnections program

Primary**Connections** is an innovative program that links the teaching of science and literacy in the primary years of schooling. It is an exciting and rewarding approach for teachers and students, with a professional learning program and supporting curriculum resources. Further information about professional learning and other curriculum support can be found on the Primary**Connections** website: www.science.org.au/primaryconnections

Developing students' scientific literacy

The learning outcomes in Primary**Connections** contribute to developing students' scientific literacy. Scientific literacy is considered the main purpose of school science education and has been described as an individual's:

- scientific knowledge and use of that knowledge to identify questions, acquire new knowledge, explain scientific phenomena and draw evidence-based conclusions about science-related issues
- understanding of the characteristic features of science as a form of human knowledge and enquiry
- awareness of how science and technology shape our material, intellectual and cultural environments
- willingness to engage in science-related issues, and with the ideas of science, as a reflective citizen (Programme for International Student Assessment & Organisation for Economic Co-operation and Development, 2009).

The PrimaryConnections teaching and learning model

This unit is one of a series designed to exemplify the Primary**Connections** teaching and learning approach, which embeds inquiry-based learning into a modified 5Es instructional model, with the five phases: *Engage*, *Explore*, *Explain*, *Elaborate* and *Evaluate* (Bybee, 1997). The relationship between the 5Es phases, investigations, literacy products and assessment is illustrated below:

Primary**Connections** 5Es teaching and learning model

Phase	Focus	Assessment focus
ENGAGE	Engage students and elicit prior knowledge	Diagnostic assessment
EXPLORE	Provide hands-on experience of the phenomenon	Formative assessment
EXPLAIN	Develop scientific explanations for observations and represent developing conceptual understanding Consider current scientific explanations	Formative assessment
ELABORATE	Extend understanding to a new context or make connections to additional concepts through a student-planned investigation	Summative assessment of the Science Inquiry Skills
EVALUATE	Students re-represent their understanding and reflect on their learning journey, and teachers collect evidence about the achievement of outcomes	Summative assessment of the Science Understanding

More information on Primary**Connections** 5Es teaching and learning model can be found at: www.science.org.au/primaryconnections/teaching-and-learning

Assessment

Assessment against the year level achievement standards of the Australian Curriculum: Science (ACARA, 2010) is ongoing and embedded in PrimaryConnections units.

Assessment is linked to the development of literacy practices and products. Relevant understandings and skills are highlighted at the beginning of each lesson. Different types of assessment are emphasised in different phases:



Diagnostic assessment occurs in the *Engage* phase. This assessment is to elicit students' prior knowledge so that the teacher can take account of this when planning how the *Explore* and *Explain* lessons will be implemented.



Formative assessment occurs in the *Explore* and *Explain* phases. This enables the teacher to monitor students' developing understanding and provide feedback that can extend and deepen students' learning.



Summative assessment of the students' achievement developed throughout the unit occurs in the *Elaborate* phase for the Science Inquiry Skills and in the *Evaluate* phase for the Science Understanding.

Linking science with literacy

PrimaryConnections has an explicit focus on developing students' knowledge, skills, understanding and capacities in science and literacy. Units employ a range of strategies to encourage students to think about, reason and represent science.

PrimaryConnections develops the literacies of science that students need to learn and to represent their understanding of science concepts, processes and skills. Representations in PrimaryConnections are multi-modal and include text, tables, graphs, models, drawings and embodied forms, such as gesture and role-play. Students use their everyday literacies to learn the new literacies of science. Science provides authentic contexts and meaningful purposes for literacy learning, and also provides opportunities to develop a wider range of literacies. Teaching science with literacy improves learning outcomes in both areas.

Alignment with the Australian Curriculum: Science

The Australian Curriculum: Science has three interrelated strands — Science Understanding, Science as a Human Endeavour and Science Inquiry Skills — that together ‘provide students with understanding, knowledge and skills through which they can develop a scientific view of the world (ACARA, 2010)’.

The content of these strands is described by the Australian Curriculum as:

Science Understanding	
Biological sciences	Understanding living things
Chemical sciences	Understanding the composition and behaviour of substances
Earth and space sciences	Understanding Earth’s dynamic structure and its place in the cosmos
Physical sciences	Understanding the nature of forces and motion, and matter and energy
Science as a Human Endeavour	
Nature and development of science	An appreciation of the unique nature of science and scientific knowledge
Use and influence of science	How science knowledge and applications affect people’s lives and how science is influenced by society and can be used to inform decisions and actions
Science Inquiry Skills	
Questioning and predicting	Identifying and constructing questions, proposing hypotheses and suggesting possible outcomes
Planning and conducting	Making decisions regarding how to investigate or solve a problem and carrying out an investigation, including the collection of data
Processing and analysing data and information	Representing data in meaningful and useful ways, identifying trends, patterns and relationships in data, and using evidence to justify conclusions
Evaluating	Considering the quality of available evidence and the merit or significance of a claim, proposition or conclusion with reference to that evidence
Communicating	Conveying information or ideas to others through appropriate representations, text types and modes

 All the material in this table is sourced from the Australian Curriculum.

There will be a minimum of four Primary**Connections** units for each year of primary school from Foundation to Year 6 — at least one for each Science Understanding sub-strand of the Australian Curriculum. Each unit contains detailed information about its alignment with all aspects of the Australian Curriculum: Science and its links to the Australian Curriculum: English and Mathematics.



Safety

Learning to use materials and equipment safely is central to working scientifically. It is important, however, for teachers to review each lesson before teaching to identify and manage safety issues specific to a group of students. A safety icon  is included in lessons where there is a need to pay particular attention to potential safety hazards. The following guidelines will help minimise risks:

- Be aware of the school's policy on safety in the classroom and for excursions.
- Check students' health records for allergies or other health issues.
- Be aware of potential dangers by trying out activities before students do them.
- Caution students about potential dangers before they begin an activity.
- Clean up spills immediately as slippery floors are dangerous.
- Instruct students never to smell, taste or eat anything unless they are given permission.
- Discuss and display a list of safe practices for science activities.

References

Australian Curriculum Assessment and Reporting Authority (ACARA). (2010). *Australian Curriculum: Science*. www.australiancurriculum.edu.au

Bybee, R.W. (1997). *Achieving scientific literacy: from purposes to practical action*. Portsmouth, NH: Heinemann.

Programme for International Student Assessment & Organisation for Economic Co-operation and Development. (2009). *PISA 2009 assessment framework: key competencies in reading, mathematics and science*. Paris: OECD Publishing.

Unit at a glance

Essential energy

Phase	Lesson	At a glance
ENGAGE	Lesson 1 Scientific support	To capture students' interest, and to find out what they think they know about how energy from a variety of sources can be used to generate electricity To elicit students' questions about the use and management of electricity
EXPLORE	Lesson 2 Susceptible to shortages Session 1 Delicate definitions Session 2 Marvellous machines	To provide hands-on, shared experiences of types of energy and what energy is used for
	Lesson 3 Here comes the Sun	To provide hands-on, shared experiences of simple energy transfers
	Lesson 4 Mobilising movement Session 1 Whirling water Session 2 Winning waterwheels	To provide hands-on, shared experiences of simple energy transformations
EXPLAIN	Lesson 5 Domestic help	To support students to represent and explain their understanding of how energy can be transferred or transformed, and to introduce current scientific views about how electricity is generated
	Lesson 6 Necessary energy	To support students to represent their understanding of how and why electrical energy is used in the home, and to introduce current scientific views about sustainable energy sources
ELABORATE	Lesson 7 Full of potential	To support students to plan and conduct an investigation of how to generate electricity using simple household items
EVALUATE	Lesson 8 Community choices	To provide opportunities for students to represent what they know about how energy from a variety of sources can be used to generate electricity, and to reflect on their learning during the unit

A unit overview can be found in Appendix 10, page 102.

Alignment with the Australian Curriculum: Science

Essential energy embeds the three strands of the Australian Curriculum: Science.

The particular sub-strands and their content for Year 6 that are relevant to this unit are shown below.

Strand	Sub-strand	Code	Year 6 content descriptions	Lessons
Science Understanding	Physical sciences	ACSSU219	Energy from a variety of sources can be used to generate electricity	1–8
		ACSU097	Electrical circuits provide a means of transferring and transforming electricity	1, 5, 6, 8
Science as a Human Endeavour	Nature and development of science	ACSHE098	Science involves testing predictions by gathering data and using evidence to develop explanations of events and phenomena	1, 2, 3, 4, 7, 8
		ACSHE099	Important contributions to the advancement of science have been made by people from a range of cultures	4
	Use and influence of science	ACSHE022	Scientific understandings, discoveries and inventions are used to solve problems that directly affect people's lives	1–8
		ACSHE220	Scientific knowledge is used to inform personal and community decisions	4, 6, 7, 8
Science Inquiry Skills	Questioning and predicting	ACSIS232	With guidance, pose questions to clarify practical problems or inform a scientific investigation, and predict what the findings of an investigation might be	1, 4, 7
	Planning and conducting	ACSIS025	With guidance, plan appropriate investigation methods to answer questions or solve problems	2, 3, 4, 7
		ACSIS104	Decide which variable should be changed and measured in fair tests and accurately observe, measure and record data, using digital technologies as appropriate	4, 7
		ACSIS105	Use equipment and materials safely, identifying potential risks	3, 4, 7
	Processing and analysing data and information	ACSIS107	Construct and use a range of representations, including tables and graphs, to represent and describe observations, patterns or relationships in data, using digital technologies as appropriate	2, 3, 4, 7
		ACSIS221	Compare data with predictions and use as evidence in developing explanations	2, 3, 4, 5, 7
	Evaluating	ACSIS108	Suggest improvements to the methods used to investigate a question or solve a problem	3, 4, 7, 8
	Communicating	ACSIS110	Communicate ideas, explanations and processes in a variety of ways, including multi-modal texts	1–8

 All the material in the first four columns of this table is sourced from the Australian Curriculum.

Interrelationship of the Science strands

The interrelationship between the three strands — Science Understanding, Science as a Human Endeavour and Science Inquiry Skills — and their sub-strands is shown below. Sub-strands covered in this unit are in bold.

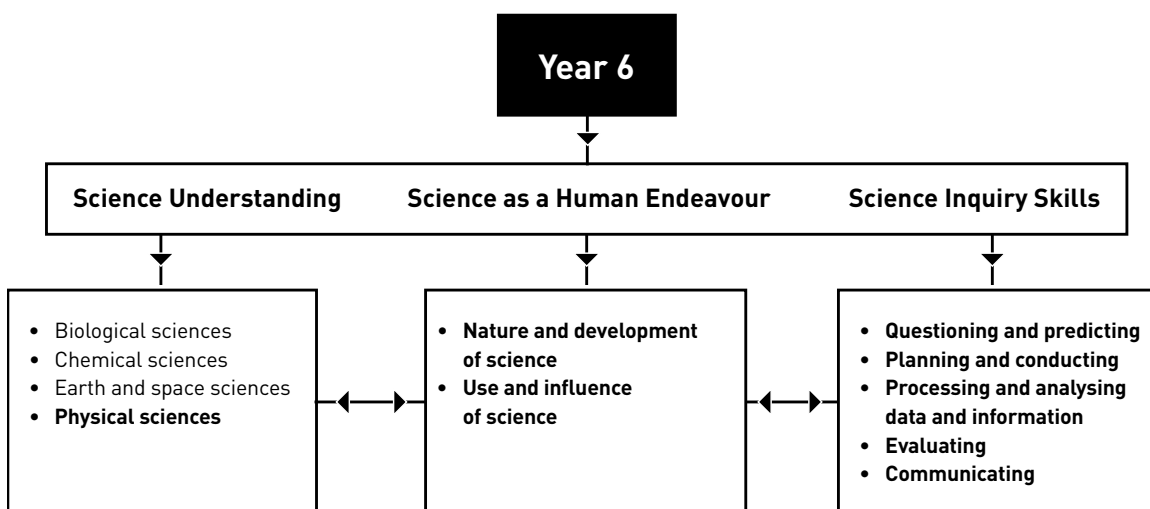

 All the terms in this diagram are sourced from the Australian Curriculum.

Relationship to Overarching ideas

In the Australian Curriculum: Science, six overarching ideas support the coherence and developmental sequence of science knowledge within and across year levels.

In *Essential energy*, these overarching ideas are represented as follows:

Overarching idea	Incorporation in <i>Essential energy</i>
Patterns, order and organisation	Students identify patterns of electricity usage in their everyday lives and classify energy types.
Form and function	Students examine the forms and functions of electrical appliances. They explore how modifications to the form of a waterwheel affect its ability to function.
Stability and change	Students explore how energy — in particular electrical energy — can be used to change the world around them.
Scale and measurement	Students conduct energy audits of appliances using correct units of measurement. They use formal measurement to compare rates of change or energy transfer when testing their waterwheels.
Matter and energy	Students identify, describe and classify different types of energy and are introduced to simple energy transfers and transformations, including the ways energy and matter interact.
Systems	Students explore simple systems of energy transfer and transformation in their homes and relate this to the larger system of energy production and distribution for a town.

Curriculum focus

The Australian Curriculum: Science is described by year level, but provides advice across four year groupings on the nature of learners. Each year grouping has a relevant curriculum focus.

Curriculum focus Years 3–6	Incorporation in <i>Essential energy</i>
<p>Recognising questions that can be investigated scientifically and investigating them</p>	<p>Students discuss different forms of energy and pose questions for investigation on how electricity is used in the home and how it is generated. They use Science Inquiry Skills to conduct fair tests on how machines can transform energy more efficiently.</p>

Achievement standards





The Achievement standards of the Australian Curriculum: Science indicate the quality of learning that students typically demonstrate by a particular point in their schooling, for example, at the end of a year level. These standards will be reviewed regularly by ACARA and are available on the ACARA website.

By the end of this unit, teachers will be able to make evidence-based judgements on whether the students are achieving below, at or above the Australian Curriculum: Science Year 6 Achievement standard. Rubrics to help teachers make these judgements are available on the website: www.science.org.au/primaryconnections/curriculum-resources

General capabilities

The skills, behaviours and attributes that students need to succeed in life and work in the twenty-first century have been identified in the Australian Curriculum as general capabilities. There are seven general capabilities, which are embedded throughout the units. For unit-specific information see the next page. For further information see: www.australiancurriculum.edu.au/generalcapabilities

Essential energy — Australian Curriculum General capabilities

General capabilities	Australian Curriculum description	Essential energy examples
Literacy	Literacy knowledge specific to the study of science develops along with scientific understanding and skills. Primary Connections learning activities explicitly introduce literacy focuses and provide students with the opportunity to use them as they think about, reason and represent their understanding of science.	In <i>Essential energy</i> the literacy focuses are: <ul style="list-style-type: none"> • science chat-boards • word walls • science journals • glossaries • tables • procedural texts • annotated diagrams • flow charts • factual texts.
 Numeracy	Elements of numeracy are particularly evident in Science Inquiry Skills. These include practical measurement and the collection, representation and interpretation of data.	Students: <ul style="list-style-type: none"> • collect, interpret and represent data about forms of energy.
Information and communication technology (ICT) competence	ICT competence is particularly evident in Science Inquiry Skills. Students use digital technologies to investigate, create, communicate, and share ideas and results.	Students are given optional opportunities to: <ul style="list-style-type: none"> • use interactive resource technology to view, record and discuss information • use the internet to research further information about forms of energy.
 Critical and creative thinking	Students develop critical and creative thinking as they speculate and solve problems through investigations, make evidence-based decisions, and analyse and evaluate information sources to draw conclusions. They develop creative questions and suggest novel solutions.	Students: <ul style="list-style-type: none"> • use reasoning to develop questions for inquiry • formulate, pose and respond to questions • develop evidence-based claims.
Ethical behaviour	Students develop ethical behaviour as they explore principles and guidelines in gathering evidence, and consider the implications of their investigations on others and the environment.	Students: <ul style="list-style-type: none"> • ask questions of others, respecting each other's point of view.
 Personal and social competence	Students develop personal and social competence as they learn to work effectively in teams, develop collaborative methods of inquiry, work safely and use their scientific knowledge to make informed choices.	Students: <ul style="list-style-type: none"> • work collaboratively in teams • participate in discussions.
 Intercultural understanding	Intercultural understanding is particularly evident in Science as a Human Endeavour. Students learn about the influence of people from a variety of cultures on the development of scientific understanding.	<ul style="list-style-type: none"> • 'Cultural perspectives' opportunities are highlighted where relevant. • Important contributions made to science by people from a range of cultures are highlighted where relevant.

 All the material in the first two columns of this table is sourced from the Australian Curriculum.

Cross curriculum priorities

There are three cross curriculum priorities identified by the Australian Curriculum:

- Aboriginal and Torres Strait Islander histories and cultures
- Asia and Australia's engagement with Asia
- Sustainability.

Two of these are embedded within this unit as described below. For further information see: www.australiancurriculum.edu.au/CrossCurriculumPriorities

Aboriginal and Torres Strait Islander histories and cultures



PrimaryConnections has developed an Indigenous perspective framework that has informed practical reflections on intercultural understanding. It can be accessed at: www.science.org.au/primaryconnections/indigenous

Essential energy focuses on the Western science way of making evidence-based claims about energy, its sources (both renewable and non-renewable), and the way it is transferred between objects and transformed from one form to another.

Indigenous cultures might have different explanations for understanding energy, its sources and behaviour.

PrimaryConnections recommends working with Indigenous community members to access contextualised, relevant Indigenous perspectives. Protocols on seeking out and engaging Indigenous community members are discussed in state and territory Indigenous education policy documents, and can be found on the PrimaryConnections website.

Sustainability

In *Essential energy*, students explore the concept of energy itself and the way it can be transferred from one place to another and transformed from one form to another. These concepts are at the centre of current energy debates, so prevalent in the world with its increasing population and the corresponding increase in demands for energy.

The unit provides students with opportunities to develop an understanding of some of the challenges facing humanity in the demand and supply of energy. This can assist students to develop knowledge, skills and values for making decisions about individual and community actions that contribute to sustainable patterns of use of the Earth's natural resources, including energy sources.

Alignment with the Australian Curriculum: English and Mathematics

Strand	Sub-strand	Code	Year 6 content descriptions	Lessons
English – Language	Language variation and change	ACELA1515	Understand that different social and geographical dialects or accents are used in Australia in addition to Standard Australian English	1, 3, 4, 5, 6, 7, 8
	Language for interaction	ACELA1517	Understand the uses of objective and subjective language and bias	1, 3, 6
	Text structure and organisation	ACELA1518	Understand how authors often innovate on text structures and play with language features to achieve particular aesthetic, humorous and persuasive purposes and effects	1, 7, 8
	Expressing and developing ideas	ACELA1524	Identify and explain how analytical images, such as figures, tables, diagrams, maps and graphs, contribute to our understanding of verbal information in factual and persuasive texts	1, 3, 4, 5, 6, 7
		ACELA1525	Investigate how vocabulary choices, including evaluative language, can express shades of meaning, feeling and opinion	3, 4, 6, 7, 8
English – Literature	Literature and context	ACELT1613	Make connections between students' own experiences and those of characters and events represented in texts drawn from different historical, social and cultural contexts	5, 8
English – Literacy	Interaction with others	ACELY1709	Participate in and contribute to discussions, clarifying and interrogating ideas, developing and supporting arguments, sharing and evaluating information, experiences and opinions	1, 2, 3, 4, 6, 7, 8
		ACELY1816	Use interaction skills, varying conventions of spoken interactions, such as voice volume, tone, pitch and pace, according to group size, formality of interaction, and needs and expertise of the audience	1–8
		ACELY1710	Plan, rehearse and deliver presentations, selecting and sequencing appropriate content and multi-modal elements for defined audiences and purposes, making appropriate choices for modality and emphasis	8
	Interpreting, analysing, evaluating	ACELY1713	Use comprehension strategies to interpret and analyse information and ideas, comparing content from a variety of textual sources including media and digital texts	1, 2, 3, 4, 5, 7, 8
		ACELY1801	Analyse strategies authors use to influence readers	8
	Creating texts	ACELY1714	Plan, draft and publish imaginative, informative and persuasive texts, choosing and experimenting with text structures, language features, images and digital resources appropriate to purpose and audience	6, 7
	Mathematics	Measurement and geometry	ACMNA123	Select and apply efficient mental and written strategies, and appropriate digital technologies to solve problems involving all four operations with whole numbers
Statistics and probability		ACMSP147	Interpret and compare a range of data displays, including side-by-side column graphs for two categorical variables	2
		ACMSP148	Interpret secondary data presented in digital media and elsewhere	5

 All the material in the first four columns of this table is sourced from the Australian Curriculum.

Other links are highlighted at the end of lessons where possible. These links will be revised and updated on the website: www.science.org.au/primaryconnections/curriculum-resources

Introduction to energy

Teacher background information

Energy is a commonly used but abstract term. It isn't a concrete entity. We might refer to a food item having a particular energy content measured in kilojoules, speak about 'feeling energetic' or refer to the rising costs of our 'energy bills'. In physics, 'energy' has a very specific meaning — the capacity of a physical system to do work. However, this isn't useful for primary students.

For the purposes of this unit, energy is a job-doing capability. So it is more useful to explore its characteristics and describe what it does, rather than try to consider definitions. A bowling ball speeding down a bowling alley has energy because it has the capacity to bowl over pins, knocking them down. Whenever a system changes, energy is at the heart of the change. It is transferred between objects or transformed from one form to another, such as electrical energy to light or heat energy, often interacting with matter along the way.

Energy cannot be created or destroyed: only transferred or transformed (nuclear reactions can transform mass into energy; however this concept is not explored in this unit).

The current concerns about reducing energy usage relate to the depletion of traditional non-renewable energy sources, such as coal, oil and gas. Once coal, oil or gas are burnt, much of the energy they originally contained is dissipated in the form of heat or light energy, either directly in the energy generation process or from the use made of that energy. The light or heat energy gradually spreads out in the atmosphere and into space. That energy is still present in the universe, but it is no longer useful for humans.

Energy can be stored. A good example of this can be found in plants. Plants require energy in the form of sunlight to photosynthesise (make their own food). They store this energy in complex sugars in order to use it at night when sunlight is not available. Plant eaters, such as humans, can release this stored energy when they metabolise the plant matter. It is this type of energy that is measured in kilojoules in our food. Electric batteries are also a good example of stored energy.

Energy can be transferred from one place to another. When it is stored, for example in energy sources such as coal, petrol, or gas, it can be physically transported by pipes, trucks or trains. Electrical energy is easily transferred through cables and wires between power stations and homes to appliances that require it. However, other forms of energy must be transformed into electrical energy ready for transfer. This process is called 'generating electricity'.

Generating electrical energy

The most common way of generating electrical energy is to rotate a coil of metal wire that can conduct electricity, such as copper, in a magnetic field or vice versa. The result is that the outer electrons of the metal atoms are 'freed up' to flow through the conducting wire. A flow of electrons is an electric current. The large machines found in power plants, called turbines and generators, do this on a large scale with energy being taken from different sources.

Power stations can use different energy sources, but in general the energy from a type of fuel (fossil fuels or nuclear power) is transformed into heat energy. This heat energy creates high-pressure streams of gas that expand in the turbine system, rotating blades that create

the movement energy necessary to generate electrical energy. This energy is made available to places such as homes, factories, hotels and shops, through the power grid. Its distribution requires sophisticated systems and back-ups because, with minor exceptions, the electrical energy cannot be stored, so production needs to meet demand.

Other ways to generate electricity include:

- using movement energy, such as in wind or water, directly to turn turbines
- transforming light energy from the Sun into photovoltaic cells (solar panels)
- transforming chemical energy into electrical energy, for example, in batteries.

Students' conceptions

Taking account of students' existing ideas is important in planning effective teaching approaches that help students learn science. Students develop their own ideas during their experiences in everyday life and might hold more than one idea about an event or phenomenon.

Energy is an abstract term, therefore students might relate energy to something tangible, such as the food they eat. Food is a commonly discussed source of energy. If we consume more food than we need, our bodies will store energy in reserves called 'fat', ready for use when consumption is lower. Students might not relate 'fat' to energy storage.

Students might confuse energy, force, motion and power. Energy is the capacity to do work; force is the influence that causes energy to effect change. A person standing next to a door has energy stored in their muscles. When the person decides to close the door, their arm and hand communicate force to the door, transmitting energy from the muscles. The amount of energy present in the system is the same; however, the door is now moving due to a force exerted upon it and the person is left with less stored energy. Power is the rate at which energy is transferred, used or transformed. In this example, power might be measured by how heavy the door is and how quickly it moves after being pushed.

Students might think that the term 'conservation of energy' is related to everyday concerns about not using too much energy. In physics, the term 'conservation of energy' refers to the principle that energy is never destroyed. In everyday life, when people talk about conserving energy, they are referring to limiting the use of energy.

References

Holdren, J.P. (2007). 'Energy challenges', in *The habitable planet: a systems approach to environmental science*. See www.learner.org/courses/envsci/index.html

Naylor, S. & Keogh, B. (2009). *Concept cartoons in science education*. Cheshire, UK: Millgate House.

Skamp, K. (Ed.). (2012). *Teaching primary science constructively* (4th Edn). South Melbourne: Cengage Learning Australia.

To access more in-depth science information in the form of text, diagrams and animations, refer to the Primary**Connections** Science Background CD, which has now been loaded on the Primary**Connections** website: www.science.org.au/primaryconnections. Note that this background information is intended for the teacher only.

Lesson 1 Scientific support

AT A GLANCE

To capture students' interest and find out what they think they know about how energy from a variety of sources can be used to generate electricity.

To elicit students' questions about the use and management of electricity.

Students:

- discuss what they think they know about energy and what electrical energy is used for
- share ideas using a think-box strategy
- record ideas on the science chat-board.

ENGAGE

Lesson focus

The focus of the *Engage* phase is to spark students' interest, stimulate their curiosity, raise questions for inquiry and elicit their existing beliefs about the topic. These existing ideas can then be taken account of in future lessons.

Assessment focus



Diagnostic assessment is an important aspect of the *Engage* phase. In this lesson you will elicit what students already know and understand about:

- different sources of energy and whether these can be used to generate electricity.
- why electricity is transferred to the home and what it is transformed into (used for).

Key lesson outcomes

Students will be able to represent their current understanding as they:

- discuss different sources of energy and how the types of energy could be transformed or transferred
- contribute to discussions about electricity, how it is used and how it is generated
- identify the purpose and features of a science journal, word wall and chat-board
- work in teams to sort and classify ideas
- pose questions for investigation in response to a request for assistance.

This lesson also provides opportunities to monitor the development of students' general capabilities (highlighted through icons, see page 5).

Teacher background information

This unit of work uses a fictional organisation — 'Special Taskforce Investigating Villains with Superpowers (STIVS)' — which is seeking help from the students. It interacts with the students by writing formal letters. This interaction allows students to meaningfully explore Science as a Human Endeavour without the stress of the equally unreal situation where 'real life' adults would be relying on their input.

If you have concerns about the reception of this learning strategy in your class, consider variations including showing clips such as the 'Planeteers' and discussing the superhero genre as a vehicle for learning science concepts before introducing it. Students are given a chance to formally answer this request for help in the *Explain* phase. However, they could also engage in an ongoing dialogue with STIVS as their learning unfolds.

Equipment

FOR THE CLASS

- class science journal
- 1 enlarged copy of 'Request for scientific support' (Resource sheet 1, see 'Preparation')
- 5 shoe boxes or similar (see 'Preparation')
- 6 large sheets of paper or cardboard (see 'Preparation')
- 6 marking pens
- team roles chart
- team skills chart
- word wall

FOR EACH TEAM

- role wristbands or badges for Director, Manager and Speaker
- each team member's science journal
- adhesive tape
- marking pens
- self-adhesive notes

Preparation

- Read 'How to organise collaborative learning teams' (Appendix 1). Display an enlarged copy of the team skills chart and the team roles chart in the classroom. Prepare role wristbands or badges and the equipment table.
- Read 'How to use a science journal' (Appendix 2).
- Read 'How to use a word wall' (Appendix 3), and create a word wall for the class.
- Prepare an enlarged copy of 'Request for scientific support' (Resource sheet 1). Organise for the students to receive it via a courier or email.
- Cut a slit in the lids of five shoe boxes or similar for use as think-boxes in Lesson step 6. Number and label the boxes: Question 1, Question 2, Question 3, Question 4 and Question 5.
- Prepare six large sheets of paper (join two A3 sheets together or use butcher's paper). In Lesson step 3 these sheets will be labelled and will provide an area for students to record keywords, pictures, questions, ideas and reflections using self-adhesive notes. Collectively, these sheets are the science chat-board for the unit.
- Organise an area in the classroom to display the science chat-board for ease of use.
- *Optional:* Colour-code the questions and self-adhesive notes to identify the different sections of the science chat-board or use different colours to represent questions, key words, ideas and thoughts.
- *Optional:* Display the science journal, chat-board and an email version of 'Request for scientific support' (Resource sheet 1) on an interactive whiteboard or a computer connected to a projector. Check the **PrimaryConnections** website to see if an accompanying interactive resource has been developed: www.science.org.au/primaryconnections
- Begin collecting electrical equipment, including voltmeters if possible, for Lesson 7.

Lesson steps

- 1 Deliver the enlarged copy of 'Request for scientific support' (see 'Preparation'). Read with the class and discuss any difficult words or phrases. Agree to start helping the 'Special Taskforce Investigating Villains with Superpowers' (STIVS), and arrange for a letter with the code name 'Live Wires' to be returned with the courier.
- 2 Ask five students to record each of the questions from 'Request for scientific support' (Resource sheet 1) on a large sheet of paper. Record 'Word wall' on the sixth sheet. Display these charts in the classroom to form a science chat-board (see 'Preparation'). Discuss the purpose and features of a science chat-board.

Literacy focus

Why do we use a science chat-board?

A **science chat-board** is a display area where we share our changing questions, ideas, thoughts and findings about a science topic.

What does a science chat-board include?

A **science chat-board** might include dates and times, written text, drawings, measurements, labelled diagrams, photographs, tables and graphs.

Optional: Organise a schedule for students to contribute to the science chat-board to ensure all students have time and the opportunity to make regular contributions.

- 3 Introduce the five think-boxes that match each question and explain that students are going to work individually to record their ideas about the five questions. Explain to students that this is an anonymous activity and they are not to write their name with their responses.
- 4 Model how to write and draw a response to a question on a self-adhesive note and place it in the matching think-box.



- 5 Allow students time to complete five self-adhesive notes and place their responses in the matching think-boxes.
- 6 Explain that students will work in collaborative learning teams to categorise and record responses from one of the think-boxes. Discuss how to divide the responsibilities, for example, by assigning two or three teams to each box and dividing responses equally between them.
- 7 Explain that team members will take turns to read the responses and contribute to sorting the responses into categories. Explain that the Director will record the chosen categories and place the corresponding responses on the large sheet of paper with the corresponding question.

Note: Using think-boxes is a way to elicit students' conceptions in an anonymous and non-judgemental way. The analysis and sorting of the responses allow for discussion and appreciation that there can be a range of views and understanding of the concept. The role of the teacher is to question and ensure that different views are classified and understood by everyone.



- 8 Form teams, allocate roles and ask Managers to collect team equipment. Allow time for teams to complete the task. Encourage students to discuss ideas in a non-confrontational way.

If students are using collaborative learning teams for the first time, introduce and explain the team skills chart and team roles chart. Explain that students will wear role wristbands or badges to help them (and you) know which role each team member has.



- 9 Display the charts to form the science chat-board. As a class, review what they think they know and discuss what evidence or information might be useful to help them. Ask students to suggest questions that they have and record them on the relevant sections of the science chat-board.

Note: An optional opportunity for students to do research on their specific questions that are not answered in the *Explore* lessons is provided in the *Explain* lesson. If there is an interesting and relevant question that leads to a feasible investigation, consider adding an *Explore* lesson to investigate it.

- 10 Introduce the word wall and discuss its features and purpose. Record key vocabulary about energy on the word wall section of the science chat-board.

Literacy focus

Why do we use a word wall?

We use a **word wall** to record words we know or learn about a topic. We display the word wall in the classroom so that we can look up words we are learning about and see how they are spelt.

What does a word wall include?

A **word wall** might include a topic title or picture and words that we have seen or heard about the topic.

-  Invite students to contribute words from different languages to the word wall, including words from local dialects that are used in addition to Standard Australian English, and discuss.
- 11** Introduce the class science journal and discuss the purpose and features of a science journal.

Literacy focus

Why do we use a science journal?

We use a **science journal** to record what we see, hear, feel and think so that we can look at it later to help us with our claims and evidence.

What does a science journal include?

A **science journal** might include dates and times, written text, drawings, measurements, labelled diagrams, photographs, tables and graphs.

-  Ask students to create an entry in their science journal about the lesson.

Australian Curriculum links

English

- Discuss features of formal letters, such as addresses, the date and appropriate forms of address including 'Dear Sir/Madam' and 'Yours sincerely', and compare them with non-formal letters.
- Discuss similarities and differences between different superhero comic books.



Request for scientific support

Dear Class

We are contacting you with a top-secret request. We are concerned about the villain Professor Pitch-black and her sidekick Short Circuit, enemies of the superhero Electric Boy. They appear to be headed towards your town. They are not dangerous but they do enjoy making mischief.

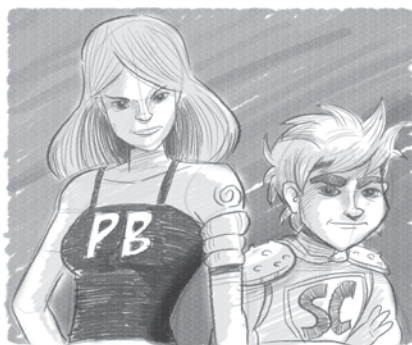

Artist's impression of the villains

Our request seems implausible and most scientists are too busy to help us out. We are asking you to provide the scientific back-up we need. We hope you will consider our questions carefully and provide answers after relevant scientific investigation.

We infiltrated their lair using a spider with a wireless microphone attached to its back to record a conversation between them. Unfortunately, all we could make out was: '[bzzzz] take away the [bzzzz] energy of [bzzzz] which would mean they couldn't transfer or transform [bzzzz] and wouldn't have the electricity they need [bzzzz] [evil laughter]'.

We are struggling to understand this piece of evidence. Our questions are:

1. What type of energy might they be talking about?
2. What happens when energy is transferred?
3. What happens if energy is transformed?
4. How is electricity made?
5. What is electricity used for?

We humbly request your aid as our field officers cannot spare the time to think about these questions. I cannot give you details of our location, for your safety and for ours. If you wish to accept this mission please write 'Live Wires' (your code name) in a letter and give it discreetly to the courier who delivered this letter (they will know what to do).

Sincere salutations
Ima Constable
Chief Investigator, STIVS

Lesson 2 Susceptible to shortages

AT A GLANCE

To provide hands-on, shared experiences of types of energy and what energy is used for.

Session 1 Delicate definitions

Students:

- explore the different types of energy identified by scientists
- observe the different types of energy used in their school.

Session 2 Marvellous machines

Students:

- identify how household machines transform one type of energy into another
- explore electrical energy usage in and around the home.

EXPLORE

Lesson focus

The *Explore* phase is designed to provide students with hands-on experiences of the science phenomenon. Students explore ideas, collect evidence, discuss their observations and keep records, such as science journal entries. The *Explore* phase ensures all students have a shared experience that can be discussed and explained in the *Explain* phase.

Assessment focus



Formative assessment is an ongoing aspect of the *Explore* phase. It involves monitoring students' developing understanding and giving feedback that extends their learning. In this lesson you will monitor students' developing understanding of:

- the different types of energy.

Key lesson outcomes

Students will be able to:

- identify different types of energy
- work in collaborative learning teams to observe different types of energy in the school
- record their observations in a table
- discuss and compare their observations
- explore and document electricity use in their home.

This lesson also provides opportunities to monitor the development of students' general capabilities (highlighted through icons, see page 5).

Teacher background information

Types of energy

Energy makes things work — it produces changes and makes things happen. It is an abstract idea to describe the cause of certain events. It is useful to think of it in terms of the effects it can produce, rather than trying to think of what it is.

Energy from the Sun can be described on a spectrum called the electro-magnetic spectrum and includes visible light, infra-red radiation, ultra-violet radiation, radio waves, microwaves, gamma rays and x-rays. A microwave oven produces electro-magnetic radiation called microwaves that penetrate an object whose water molecules begin to vibrate more quickly, causing the object to become hot. For students in primary school, some generalisations will be made in this unit.

For the purposes of this unit, the following energy types will be considered:

- **Movement:** describes the displacement of an object in time and space.
- **Electrical:** describes the displacement of electrons around a closed circuit.
- **Light:** describes electro-magnetic radiation that is detected by the retina in the eye.
- **Heat:** describes the speed at which particles in matter vibrate. The hotter something is, the more energy its particles have and the more vigorously they vibrate.
- **Microwaves:** describes electromagnetic radiation of high frequency and short wavelength that can cause particles such as water molecules to vibrate faster.
- **Sound:** describes waves of pressure travelling through solids, liquids or gases that our ears perceive as sound.
- **Elastic:** describes how certain materials stretch when they are pulled (have opposing forces applied), and store the applied energy. They have the ability to then spring back to their original shape, transforming stored energy to movement energy.

- **Gravitational:** describes how any object near Earth that is not restrained in any way, will drop towards the Earth's centre. Gravitational energy, as it is used here, is a measure relative to position. A book on a high shelf is said to have more 'gravitational' energy than one on a low shelf, since when it falls from the shelf the higher one will gain more movement energy as it falls.
- **Chemical:** describes the fact that all chemicals have a certain amount of energy in the bonds that hold the atoms together. For example, complex carbohydrates and fats have high energy bonds that animals and plants break down to release energy.
- **Nuclear:** describes the energy released when the nuclei of atoms are split (fission) and/or combined (fusion). The Sun is a site of nuclear fusion where hydrogen atom nuclei fuse to form a helium atom nucleus, releasing radiations of many types, including light, heat waves and ultraviolet radiations, that are so energetic they can burn skin and/or damage DNA.

Transfer and transformation of energy

Energy is transferred when it passes from object to object, for example, when a cricket bat hits a ball. Initially, the bat has movement energy. After contact, the ball has movement energy that is transferred from the bat. Energy is transformed when it takes on a different form of energy. For example, when you connect a light bulb to an electric circuit, the light bulb transforms electrical energy into light energy and some heat energy.

Machines

Machines transform one type of energy into another. For example, a hair dryer transforms electrical energy into movement energy (moving air) and heat energy (which heats the air). A power station takes the energy from different sources in the environment, such as coal and running water, and transforms it into electrical energy. The mechanics of energy transformation are not discussed in this lesson, but it is essential to understand that machines transfer or transform energy. Home appliances are machines used in the home to accomplish specific tasks, such as cooking or cleaning. They use electrical energy to accomplish their task.

Power

The amount of energy produced or used by a system at a given time is referred to as 'power'. Power is measured in watts (W). Large-scale power usage, such as that used by a household, is measured in kilowatts (kW). Power can also be measured over a period of time. This gives an indication of the total amount of energy used rather than being an instantaneous measure. The unit for power over a period of time is a watt hour (Wh) or a kilowatt hour (kWh). This is the unit commonly used on household power bills to indicate usage.

An audit of the appliances used in students' homes will show the energy usage for that week in watt hours. This usage is likely to be different at varying times of the year. For example, clothes dryers are likely to be used more often in Winter than Summer, but this might be balanced by the use of air conditioners in Summer.

Students' conceptions

Students might confuse energy with power. Energy is the capacity to do work, whereas power is a measure of the amount of work achieved in a given time or the rate at which work is done.

Students might think that energy is created by wind, water, the Sun or even power stations. However, energy cannot be created or destroyed; it is merely transformed into other forms of energy or transferred to other objects. Energy resources contain energy types that can be transformed for our use. Power stations that use coal, wind or other energy resources transfer or transform this energy so it can be used and distributed easily in the form of electricity. Students might also believe that energy is fuel. Fuel is another name for an energy source.

Students might believe that only objects in motion have energy. Moving objects do have energy, but there are many other types of energy. For example, a hot object has more heat energy than a cold one, and a book stored on a high shelf has more gravitational energy than a book stored on a low shelf.

Students might not hold concepts about stored forms of energy. We can store energy in a stretched elastic band or spring (elastic energy) because when released, the springs and elastic bands move back into their original position. An object up high has the potential to fall, and through falling converts its gravitational energy into movement energy. When held up high, a child's swing in a park stores gravitational energy. As it swings downwards, the gravitational energy is transformed into movement energy (and some heat due to friction and wind resistance). As it swings upwards again, it re-transforms movement energy into gravitational energy. A battery stores chemical energy.

Students might not think of their own bodies as 'machines' that require energy to do work. Every function carried out by our bodies, even the smallest involuntary action, requires energy that we metabolise from food. The chemical energy stored in the food is released and eventually transformed into the many forms of energy needed to carry out tasks, such as the contraction of a muscle group when lifting an object.

Session 1 Delicate definitions

Equipment

FOR THE CLASS

- class science journal
- word wall
- team skills chart
- team roles chart
- 'Types of energy' cards for the science chat-board (see 'Preparation')
- 1 enlarged copy of 'School energy survey' (Resource sheet 2)
- 1 or more resource(s) containing a scientific definition of 'energy', (eg, an encyclopaedia)

FOR EACH TEAM

- role wristbands or badges for Director, Manager and Speaker
- each team member's science journal
- 1 copy of 'School energy survey' (Resource sheet 2)
- 1 pen
- *Optional:* 1 clipboard

Preparation

- Read 'How to use a glossary' (Appendix 4).
- Create 11 cards to be affixed to the science chat-board. On each card write a different type of energy (see 'Teacher background information'): movement, heat, light, sound, electrical, elastic, gravitational, magnetic, chemical and nuclear.
- Prepare an enlarged copy of 'School energy survey' (Resource sheet 2).
- *Optional:* Display the 'Types of energy' cards and 'School energy survey' (Resource sheet 2) on an interactive whiteboard or a computer connected to a projector. Check the PrimaryConnections website to see if an accompanying interactive resource has been developed: www.science.org.au/primaryconnections

Lesson steps

- 1 Review the previous lesson, focusing students' attention on STIVS' questions about different types of energy and students' thoughts.
- 2 Discuss the purpose and features of a glossary, and explain to students that as the unit progresses, they will create a glossary in their science journal.

Literacy focus

Why do we use a glossary?

We use a **glossary** to provide descriptions of technical terms that relate to a particular subject matter or topic.

What does a glossary include?

A **glossary** includes a list of technical terms in alphabetical order, accompanied by a description or an explanation of the term in the context of the subject.



- Remind students that many dictionaries and glossaries have several different descriptions for a word, as it can mean different things in different situations.
- 3 Model how to develop a glossary in the class science journal using the term 'energy'. Write the term in the science journal and follow it with the sub-title 'common usage'. Invite students to describe what they think the term 'energy' means in their everyday lives. Add the agreed description to the glossary in the class science journal.
 - 4 Write the sub-title 'scientific usage' under the term 'energy' in the glossary in the class science journal. Use the scientific resource(s) (see 'Equipment') to create a scientific description of the word 'energy' and record its title as reference material.

Discuss why scientists might have different definitions of words to those used in common language, and why it is important to reference sources.



- 5 Introduce the cards with 'Types of energy' (see 'Preparation'), and explain that it can be useful to think of energy in types. Hold up each card and discuss the energy type it represents. Add the cards to the science chat-board section that relates to energy types.
- 6 Explain that students will be working in collaborative learning teams to identify what types of energy are present in the school and what they are used for.
- 7 Introduce the enlarged copy of 'School energy survey' (Resource sheet 2). Explain that Speakers will record their teams' observations in a table. Discuss the purpose and features of a table.

Literacy focus

Why do we use a table?

We use a **table** to organise information so that we can understand it more easily.

What does a table include?





A **table** includes a title, columns with headings and information organised under each heading.

- 8 Discuss the differences between columns 2 and 3 on 'School energy survey' (Resource sheet 2), for example, a book **has** gravitational energy whereas a light bulb **emits** light energy and **uses** electrical energy. Model filling in an observation in the table of the enlarged copy of 'School energy survey' (Resource sheet 2), using an example from the classroom.

Note: Ensure that the 'Where it comes from' column contains at least one made machine, for example, a light bulb. The enlarged copy of 'School energy survey' (Resource sheet 2) with its example of an entry will be used again in Lesson 2, Session 2, Lesson step 5.

Object	Energy it has/is emitting	Energy it is using
Computer screen	light	electricity
speaker	sound	electricity
alarm bell	sound	movement of hammer / electricity to move hammer
tree	chemical	light
book on shelf	gravitational	none but movement put it there.

Work sample of 'School energy survey'

-  **9** Discuss appropriate behaviours when walking through the school, for example, talking should be quiet so as not to disturb others.
- 10** Form teams and allocate roles. Ask Managers to collect team equipment.
- 11** Organise the class to go for a walk around the school.
-  **12** After returning to the classroom, ask Speakers to share some observations they have recorded. Encourage students in the audience to use 'Science question starters' (see Appendix 5) to ask about their observations.
-  **13** As a class, discuss what students have observed, asking questions such as:
- What types of energy are present in the school?
 - What types of energy are not present in the school?
 - What types of energy are used most in the school? Why do you think that?
- Record students' responses in the class science journal.
-  **14** Allow time for students to write in their science journal. Ask students to begin their own individual glossary, including the word 'energy'. Support students' writing with sentence beginnings, such as:
- Today we...
 - I found out that...
 - I think it would be useful for STIVS to know...
 - I enjoyed/did not enjoy...
 - I want to know more about...
- Note:** Encourage students to revisit the glossary as the unit progresses so they can change, update and/or confirm their descriptions of key vocabulary.
- Optional:* Organise for a progress report to be sent to STIVS, either individually or as a class.
- 15** Update the science chat-board, including the word wall, with words and images.

Session 2 Marvellous machines

Equipment

FOR THE CLASS

- class science journal
- word wall
- 1 enlarged copy of 'Auditing appliances' (Resource sheet 4)

FOR EACH TEAM

- each team member's science journal
- 1 'Auditing appliances' folder (eg, a manila folder)
- 1 copy of 'Information note for families' (Resource sheet 3)
- 1 copy of 'Auditing appliances' (Resource sheet 4)
- 1 copy of 'Energy usage guide' (see 'Preparation')

Preparation

- Decide whether students will present their findings during the one session or over several sessions. Record the date for students to present their findings and include it on 'Information note for families' (Resource sheet 3).
- **Note:** It is preferable that students complete their observations before Lesson 6 (*Explain*). Make an 'Auditing appliances' folder for each student and include a copy of 'Information note for families' (Resource sheet 3), 'Auditing appliances' (Resource sheet 4) and 'Energy usage guide' from Energy Australia.
- See: www.ruralresidentialliving.com.au/saving_energy/resource_downloads/Energy%20Usage%20Guide.pdf
- *Optional:* Display 'Auditing appliances' (Resource sheet 4) and 'Energy usage guide' on an interactive whiteboard or a computer connected to a projector. Check the **PrimaryConnections** website to see if an accompanying interactive resource has been developed: www.science.org.au/primaryconnections

Lesson steps

- 1 Review the previous session, focusing students' attention on the different types of energy that they observed in the school. Remind students of the initial letter from STIVS and the overheard conversation, asking questions such as:
 - What do we use electricity for?
 - How many different things use electricity?
- 2  Brainstorm with students for a minute on what they think of when they hear the word 'machine'. Record answers in the class science journal. Agree on a common-usage definition of the word 'machine', and record it in the glossary in the class science journal.

- 3** Introduce the ‘scientific usage’ definition of machine as something that transforms one energy type to another, or transfers energy from one object to another. Discuss the terms ‘transfer’ and ‘transform’, and add them to the class glossary. Explain that a ‘transfer’ is the movement of one type of energy from one place to another, for example, a lever transfers moving energy from one side to another. Explain that a ‘transformation’ is when one energy type takes on another form, for example, a television transforms electrical energy into sound, light and heat energy.

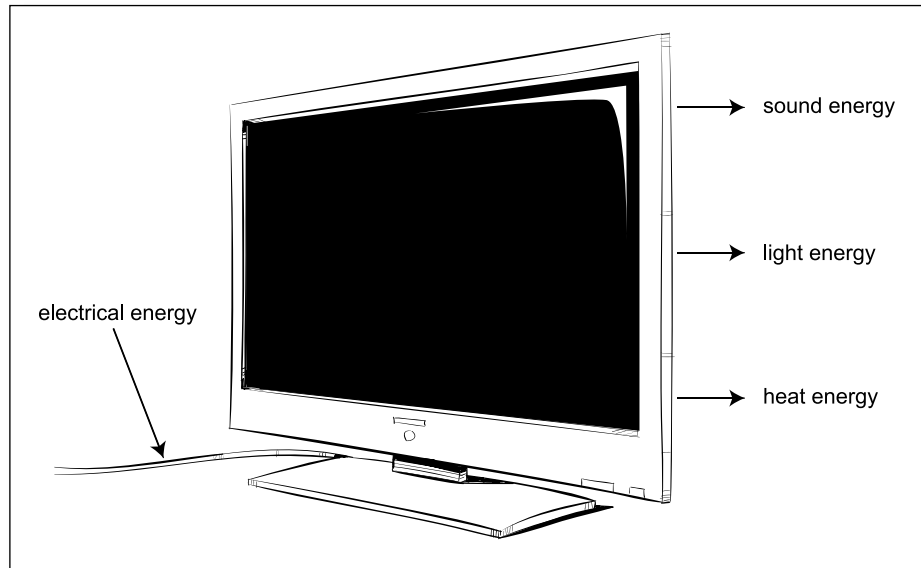

Example of energy transformation



- 4** Ask students if they can identify any examples of machines among the objects that they studied during the previous session. Ask them if the machines transfer or transform energy and what types of energy are involved.
- 5** Discuss how home appliances are machines that perform useful tasks in the home, generally by transforming electricity into other forms of energy. Explain that students are going to investigate their homes to identify appliances that are using electricity, for what purpose and how often. Add the term ‘appliance’ to the glossary in the class science journal.
- 6** Introduce the ‘Information note for families’ (Resource sheet 3), and read through with the class.
- 7** Introduce the enlarged copy of ‘Auditing appliances’ (Resource sheet 4), and discuss how to record observations about appliances. Explain that watts are a unit used to measure how quickly energy is used. For example, a 75W light globe uses energy quicker than a 15W light globe.
- 8** Model how to record an observation on the enlarged copy of ‘Auditing appliances’ (Resource sheet 4). Explain that some appliances display the number of watts they use on a sticker. If students cannot find the number of watts their appliance uses they could use the ‘Energy usage guide’. Model how to use the guide.

Appliance	What is the electricity used for?	How many hours is it used per week?	How many watts does it use?
fridge	cool and freeze food	168 hours	555 KWh per year
washing machine	wash clothes	6 hours	309 KWh per year
clothes dryer	dry clothes	4 hours	189 KWh per year

Work sample of 'Auditing appliances'

- 9 Explain to students that they will be taking the 'Auditing appliances' folder home to complete, and they will be presenting their findings to the rest of the class on a given date (see 'Preparation').
- 10 Update the science chat-board, including the word wall, with words and images.

Australian Curriculum links

Mathematics

- Ask students to calculate how much different appliances cost to run per hour given the price per watt and then per year, and to compare them with other appliances.

Information note for families

Name: _____ Date: _____

Introducing the 'Auditing appliances' task

This term, the class is exploring energy as part of the *Essential energy* unit. Students are encouraged to look at what electricity is used for in the home. They are encouraged to look at appliances in and around the home and identify what the electricity is used for, for example, to heat something, to make something move, or to produce light or sound. Some examples of appliances might be:

- a hot water heater
- a cooling system
- cooking appliances.

If you have past electricity bills, this might be helpful for students to see when spikes of energy usage occur in the home.

Students are asked to record the information on the resource sheet 'Auditing appliances', along with an estimation of how often the appliance is used in a standard week. Students are also encouraged to try to determine how many watts the appliance uses. This information is often recorded on the appliance, or they can find this information in the 'Energy usage guide' or online.

Students might record other information, for example:

- make a chart or booklet of drawings of appliances that use energy, and include labels and descriptions of what the machines are used for and what types of energy they require
- take photos of the appliances, and include labels and descriptions of what the appliances are used for and what types of energy they use.

Students will be asked to share their observations with their classmates on

Class teacher

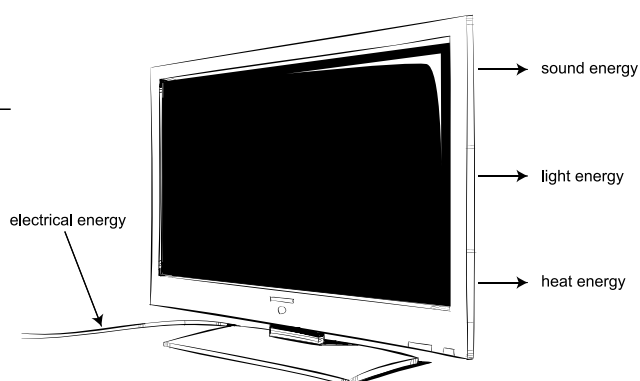



Lesson 3 Here comes the Sun

AT A GLANCE

To provide hands-on, shared experiences of simple energy transfers.

Students:

- work in collaborative learning teams to investigate how energy from the Sun can be used to heat water
- modify a soft drink can to investigate how to heat the water faster.

Lesson focus

The *Explore* phase is designed to provide students with hands-on experiences of the science phenomenon. Students explore ideas, collect evidence, discuss their observations and keep records, such as science journal entries. The *Explore* phase ensures all students have a shared experience that can be discussed and explained in the *Explain* phase.

Assessment focus



Formative assessment is an ongoing aspect of the *Explore* phase. It involves monitoring students' developing understanding and giving feedback that extends their learning. In this lesson you will monitor students' developing understanding of:

- how energy from a variety of sources can be transferred.

Key lesson outcomes

Students will be able to:
• identify that heat from the Sun can be transferred to heat water
• use a Predict, Reason, Observe and Explain (PROE) strategy to plan a simple investigation
• work in teams to safely investigate methods of improving the heating of water in a can
• record observations in a table
• compare their results with their predictions, and present to the class
• evaluate their investigation
• discuss the advantages and disadvantages of different methods of heating water.

This lesson also provides opportunities to monitor the development of students' general capabilities (highlighted through icons, see page 5).

Teacher background information

Energy from the Sun

The Sun emits many different forms of radiation, including light and heat. The radiation forms differ in their frequency as measured by the wavelengths of the radiation. Infra-red radiation is felt as warmth.

The energy from the Sun can be used by humans in several ways. Infra-red radiation heats objects, including water in pipes that can be used for our showers. The light produced by the Sun reflects from objects into our eyes, allowing us to see during the day. Some forms of radiation from the Sun are so energetic that they cause harm to our skin even though we cannot feel this happening, for example, ultra-violet (a) and ultra-violet (b). Other forms are extremely dangerous, such as gamma rays and x-rays, and fortunately these are mostly blocked by our atmosphere before they reach the Earth's surface.

Scientists have designed photovoltaic cells that transform the Sun's energy into electrical energy. These cells are arranged in solar panels and are most commonly used to power homes, calculators, weather stations and lights on street signs.

Solar hot water systems

A basic solar hot water system works on the principle of heat transfer from the Sun to water, gradually warming it. However, heat diffuses slowly in water, which is why still lakes have surface layers that are warm while the lower levels are still very cold.

Solar hot water systems are designed to capture as much energy from the Sun as possible, to make the water as hot as possible. They do this by pumping water through narrow pipes, which increases the amount of water exposed to the Sun's radiation rather than attempting to heat water in a large mass. The more efficient the solar hot water system, the more warm water is provided for the same amount of radiations from the Sun received. One way of increasing the efficiency of a solar hot water system is to ensure that as much of the radiations are captured as possible, for example, by using black materials to limit the amount of energy reflected from the surface.

Students can investigate this phenomenon using a metal can of water. Much of the Sun's radiation doesn't fall directly on a can. If it is placed on aluminium foil, the surrounding radiation is reflected onto the can by the foil. Wrapping the can in opaque fabric will reduce the efficiency of the heating system because it reduces the amount of radiation reaching the water. However if the material gets hot by absorbing sunlight it will then transfer this heat slowly to the water. Thick fabric also stops radiation from leaving the can. Therefore, if a can of warm water is insulated with thick fabric, it will stay warm longer than an unwrapped can.

Scientists have developed solar hot water systems that are very efficient. Some systems use electricity for pumping the fluid into the pipes and have a reservoir or tank to store hot water for use on days when there isn't a lot of sunlight.

Students' conceptions

Some students might think they have less energy in the Sun because the warm sunshine makes them feel sleepy. However, the sensation of lethargy is not the same as having less energy. The internal energy of humans is not directly reliant on the Sun. We eat food to give us energy and we use some of that energy to keep our body temperature warm and constant.

Equipment

FOR THE CLASS

- class science journal
- word wall
- team skills chart
- team roles chart
- 1 enlarged copy of 'PROE' (Resource sheet 5)
- bucket of water
- measuring cup

FOR EACH TEAM

- role wristbands or badges for Director, Manager and Speaker
- each team member's science journal
- 1 copy of 'PROE' (Resource sheet 5)
- 2 empty soft drink cans
- 1 thermometer
- equipment for modifying cans (see 'Preparation')

Preparation

- Read 'How to conduct a fair test' (Appendix 6).
- Collect equipment and materials for teams to modify their cans, such as different coloured paint, fabric or plastic bags to wrap the cans, plant pots to put over the cans, or foil trays for the cans to sit in. Include adhesive tape and string to help students make their modifications.
- Decide what time of day the class will carry out the investigation, for example, in the morning. Set up a soft drink can in the sunlight with water in it at approximately the same time that students will complete this session. Note how quickly the temperature of the water increases and how long it takes for a maximum temperature to be reached. Using these observations, determine an appropriate measurement interval and duration of the investigation, for example, measure the temperature every 15 minutes for an hour (see Lesson step 5).

Note: The less sunlight there is, the longer it will take for a result to become apparent. In winter the temperature of the ambient air might be so cold that it cools the water in the can as fast as the Sun warms it, so the investigation might need to be conducted inside.

- *Optional:* Display 'PROE' (Resource sheet 5) on an interactive whiteboard or a computer connected to a projector. Check the PrimaryConnections website to see if an accompanying interactive resource has been developed: www.science.org.au/primaryconnections

Lesson steps

- 1 Review the unit using the science chat-board and the class science journal, focusing students' attention on STIVS, questions about energy transfer and transformation and their thoughts.

Optional: If the class wrote progress updates to STIVS in Lesson 2, Session 1, organise to receive a letter that asks students to focus on direct energy transfer.



- 2 Ask students if they have any observations from their home project. Discuss how heating water can represent a significant cost in energy for a household. Brainstorm ways of heating water. Identify which ways involve energy transformation, for example, burning chemical energy of gas or wood, and which ways involve energy transfer, for example, solar heating.
- 3 Explain that students will be working in collaborative learning teams to investigate how best to heat water in a can, using energy from the Sun. Discuss how students will set up two cans in the sunlight, one plain and one modified, and compare the temperature of the water in each over time.
- 4 Introduce the enlarged copy of 'PROE' (Resource sheet 5), and read through with students. Ask how students will:

Predict: record how they are modifying a can to make the water heat faster, for example, by painting it black.

Reason: record a reason to support their prediction, for example, black things reflect less light so the can might absorb more sunlight if it were black.

Observe: explain that teams will be recording the temperature of the water at intervals of time (see 'Preparation') and noting their results in the table.

Explain: ask teams to compare their predictions with their observations and explain why the results did or did not match their predictions. For example, 'The black can did heat the water faster than the other can. However, the water did not get as hot as I expected. Maybe this modification could be combined with others to get an even better result'.



- 5 Discuss how to keep the test fair. For example:
- keep the quantity of water in the cans the same
 - put the two cans in the same spot in the sunlight
 - leave the cans in the sunlight for the same amount of time.

Record students' thoughts in the class science journal.



- 6 Form teams and allocate roles. Ask teams to complete the 'Predict' and 'Reason' sections of the PROE strategy on their copy of 'PROE' (Resource sheet 5).



- 7 Ask Managers to collect team equipment. Allow time for teams to complete their investigation, record their results and develop explanations.



- 8 Invite teams to share their results. Ask questions such as:



- Why do you think the water in this can heated more quickly than the water in that can?
- How might the design be improved to make the water warmer in the same amount of time in the same conditions?
- Do you think this is a good way to use energy from the Sun?

Record students' ideas in the class science journal.



- 9 Discuss the investigation with the class, asking questions such as:

- What worked well with the investigation?
- What didn't work well?
- What would you do differently next time?



- 10 Discuss the advantages and disadvantages of using the Sun to heat water for a shower using this method compared to other forms of heating. Ask questions such as:

- How many cans of water would you need to heat?
- What would you do on cloudy days?
- Could you store heat energy from the Sun?
- What are the advantages of heating water this way compared to other ways?
- What are the disadvantages of heating water this way compared to other ways?

Explain that scientists have developed hot water systems that heat water quickly and store hot water for days when there is no sunlight.

- 11 Ask students to record what they have learned and update their individual glossaries in their science journal. Support students' writing with sentence beginnings such as:
- Today we...
 - What I have learned about energy transfer is...
 - I think it would be useful for STIVS to know...
 - I enjoyed/did not enjoy...
 - I want to know more about...
- Optional:* Organise for a progress report to be sent to STIVS, either individually or as a class.
- 12 Update the science chat-board, including the word wall, with words and images.

Australian Curriculum links

Science

- Support students to plan and conduct fair test investigations in which only one variable is changed, to isolate what factors are responsible for greater heating efficiency. They could either reuse cans or create solar ovens. See: www.csiro.au/helix/sciencemail/activities/solaroven.html



Investigation of energy transfer

PROE

Team members: _____ **Date:** _____

Question for investigation: How can we heat the water in the can faster?

Predict – Predict how to modify the can to make the water heat faster.

Reason – Why do you think that modification will cause the water in the can to heat faster?

Observe – What happened?

Time	Temperature of water in plain can	Temperature of water in modified can

Notes:

Explain – What happened? What can you claim based on your evidence?

Lesson 4 Mobilising movement

AT A GLANCE

To provide hands-on shared experiences of simple energy transformations.

Session 1 Whirling water

Students:

- work in collaborative learning teams to create a waterwheel
- identify one variable to change on their waterwheel.

Session 2 Winning waterwheels

Students:

- work in collaborative learning teams to test their changed waterwheel
- discuss and compare their results.

EXPLORE

Lesson focus

The *Explore* phase is designed to provide students with hands-on experiences of the science phenomenon. Students explore ideas, collect evidence, discuss their observations and keep records such as science journal entries. The *Explore* phase ensures all students have a shared experience that can be discussed and explained in the *Explain* phase.

Assessment focus



Formative assessment is an ongoing aspect of the *Explore* phase. It involves monitoring students' developing understanding and giving feedback that extends their learning. In this lesson you will monitor students' developing understanding of:

- how energy from a variety of sources can be transferred or transformed.

Key lesson outcomes

Students will be able to:

- write a question for investigation and predict what will happen when the variable that they chose changes
- work in collaborative learning teams to plan and safely conduct an investigation about variables that affect the efficiency of a waterwheel
- record results of multiple trials in a table and calculate averages
- make evidence-based claims about their results and compare their results with their predictions and with other teams' results
- evaluate their investigation
- identify how waterwheels transfer and transform energy and have been used by different cultures for centuries
- discuss the management challenges and environmental impacts of harnessing energy from streams and rivers.

This lesson also provides opportunities to monitor the development of students' general capabilities (highlighted through icons, see page 5).

Teacher background information

Energy in water

Streams and rivers have movement energy because they flow downhill. Water that evaporates at low altitudes because of the Sun's heat can fall as rain at high altitudes. Everything on Earth, including water, is pulled towards the centre of the Earth and will move downwards if there is no obstacle. This ability to start moving is called potential, or stored, energy. The higher the altitude of an object, the greater its potential to fall. At the top of a hill, water has high potential (stored) gravitational energy. As the water flows down the hill it loses both altitude and gravitational energy, but gains movement energy (kinetic energy). River flow is also dependent on rainfall at high altitudes and flow can vary from too little (drought conditions) to too much (flood conditions).

Historically, humans have sought to control the flow of water by creating dams. By blocking water flow at a high level, the water is stored with a high potential energy to flow downwards. Dammed water is let out in measured quantities when required. This has the added advantage of ensuring constant water supplies to human populations. Water from taps and hoses can flow quite fast. In some places this is because the water comes from a storage dam that is well above the altitude of the town. Otherwise the water has to be pumped for it to move. The mains water supply of many cities has pressure added by machines.

Water turbines

Water itself does not contain energy. However, we can harness the movement energy from streams and rivers. If a waterwheel is placed in the river's or stream's path, some

of the movement energy of the water is transferred to the wheel, which begins to spin. The movement of the wheel can then be used directly, for example, to power a winch, or it can be transformed to electrical energy using a dynamo.

There are several different types of turbine that can be used to harness energy from moving water. The type used will depend on the amount of water flowing and the geographical factors, such as the height the water drops and the space available.

Humans have a long history of using waterwheels. Archaeologists have found evidence of the use of waterwheels in ancient Egypt, Greece and Rome in the 3rd century BC. They were also independently developed in China, with evidence of waterwheels being used to crush grain in the 1st century AD.

Efficiency

When energy is transferred to another object or transformed into another type, some of it is also transformed into another form of less useful energy. For example, when one marble hits another marble, the sound of the collision can be heard and the second marble heats up a fraction. The original movement energy of the first marble is transferred to the second marble, but a small amount is also transformed into sound and heat energy. The less energy that is transferred into non-desired types of energy ('lost'), the more efficient the energy transformation.

The efficiency of a waterwheel relates to many factors, for example, the angle and shape of the blades affect how well the energy is harnessed. The efficiency can also depend on environmental factors, for example, some waterwheels will perform better in different water speed ranges than others. When scientists and engineers design machines to be efficient, they pay particular attention to loss of energy through friction between moving parts. Friction can be useful, for example, to stop us from slipping when we are walking. However, inside machines, friction creates heat, causing the loss of useful energy. Too much friction might even cause parts to jam against each other or deform. Friction is minimised by the use of lubricants and special materials with surfaces that reduce friction.

Session 1 Whirling water

Equipment

FOR THE CLASS

- class science journal
- word wall
- team skills chart
- team roles chart
- enlarged copy of 'Waterwheel procedure' (Resource sheet 6)
- enlarged copy of 'Waterwheel investigation planner' (Resource sheet 7)
- 1 ice-cream or large yoghurt container
- sand or marbles to fill the container
- scissors or Stanley knife
- 1 bucket
- 1 timing device (eg, a stopwatch or a watch with a second hand)
- water

FOR EACH TEAM

- role wristbands or badges for Director, Manager and Speaker
- each team member's science journal
- 1 copy of 'Waterwheel procedure' (Resource sheet 6)
- 1 copy of 'Waterwheel investigation planner' (Resource sheet 7)
- 8 wooden skewers
- adhesive tape
- 2 pieces of adhesive tac
- 2 x 30cm pieces of string
- materials to make waterwheel blades (see 'Preparation')
- small weight (eg, an eraser)

Preparation

- Prepare a waterwheel testing station by cutting two curved notches in opposite sides of an ice-cream or large yoghurt container. An axle made from four wooden skewers taped together should sit across the container and rest in the notches. Fill the base with weight, such as marbles or sand. A steady stream of water is directed at the waterwheel blades, which are attached to the axle. The waterwheel is supported by a string attached to a weight (eg, an eraser) hanging from the side of the container.

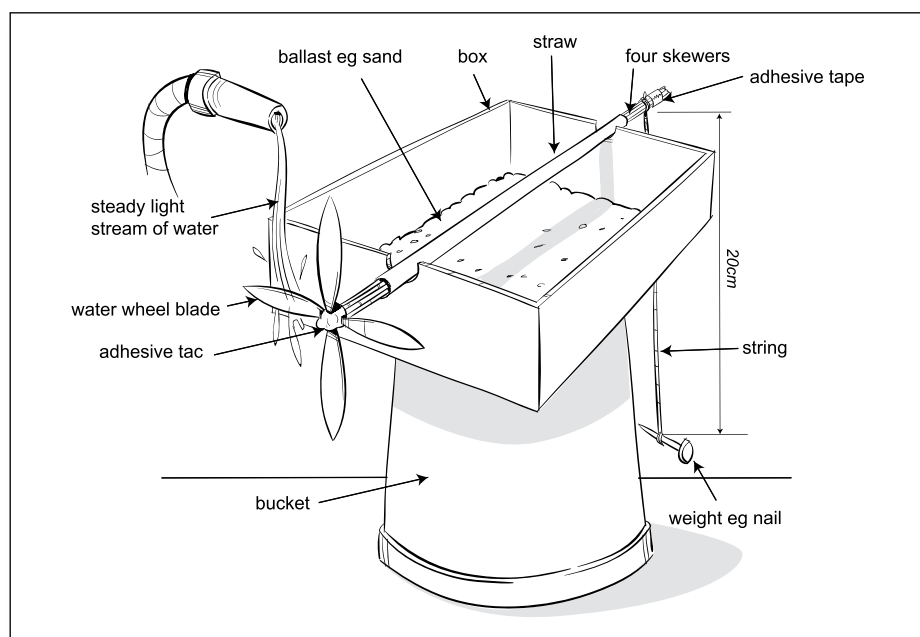

Annotated diagram of a waterwheel testing station

- Identify an area for the waterwheels to be tested, for example, outside since water might be splashed around. The waterwheel testing station will be placed on top of the upturned bucket, allowing the string with a weight attached to dangle freely. The wheel blades will be placed under a thin stream of water, for example, from an outside tap or a hose, or poured from a large bottle.

Note: This lesson can be modified to test windmills if students are more likely to relate to them given their local environment.

- Prepare a set of equipment for each team's waterwheels (see 'Preparation'). Prepare materials to build waterwheel blades, for example, disposable cups, plastic spoons, cardboard, Styrofoam sheets, plastic sheets and cardboard tubes, and place on the equipment table. Include some materials that are not waterproof, such as cardboard, to allow teams to choose materials appropriate for the waterwheel.

Note: Do not use plasticine for the wheel base as it does not adhere well to the axle, especially once it is wet. If students are having difficulty attaching the blades using this method, consider using a disk cut from an ice-cream container.

- Consider how you will organise for teams to test their waterwheels, for example:
 - one at a time during the first science session as they finish building them
 - in front of the class during the second science session
 - teams are called away from a separate task, for example, an independent reading activity.
- *Optional:* Create several testing stations with adult supervision.
- Enlarge a copy of 'Waterwheel procedure' (Resource sheet 6) and 'Waterwheel investigation planner' (Resource sheet 7).
- *Optional:* Display 'Waterwheel procedure' (Resource sheet 6) and 'Waterwheel investigation planner' (Resource sheet 7) on an interactive whiteboard or a computer connected to a projector. Check the PrimaryConnections website to see if an accompanying interactive resource has been developed: www.science.org.au/primaryconnections

Lesson steps



- 1 Review the unit using the science chat-board and the class science journal, focusing students' attention on energy transfer and transformation. Review STIVS' initial questions and brainstorm ideas of other simple energy transfers, for example, movement energy from one marble being transferred to another after a collision.

Optional: If the class wrote progress updates to STIVS at the end of Lesson 3, organise to receive a letter that asks students to focus on other simple energy transfers and transformations.



- 2 Ask students if they can think of any other types of energy that could be used in their local environment, for example, wind energy, water energy or coal energy. Record students' thoughts in the class science journal.
- 3 Explain that in this lesson students will be exploring how humans can use movement energy, such as that contained in wind or streams. Explain that students will be working in collaborative learning teams to build a wheel that can be turned by running water and lift a small weight.

- 4 Explain that students will be testing the efficiency of their waterwheels. Discuss what the term 'efficiency' might mean in terms of machines using energy. Introduce the idea that efficiency is the amount of 'useful' energy a machine produces compared to how much energy it receives. Add the term 'efficiency' to the glossary in the class science journal.
- 5 Introduce the enlarged copy of 'Waterwheel procedure' (Resource sheet 6), and read through with students. Discuss the purpose and features of a procedural text.



Literacy focus

Why do we use a procedural text?

We use a **procedural text** to find out how something is done.

What does a procedural text include?

A **procedural text** includes a title, a list of materials that we need to do a task, and a sequence of steps to follow. It might include labelled diagrams.

- 6 Discuss with students how they would know if one waterwheel was more efficient than another, for example, a more efficient waterwheel would lift the weight faster.
- 7 Ask students what things might affect the efficiency of a waterwheel. Brainstorm variables, such as the number of blades, material the blades are made of, the size of the blades, the angle of the blades, how the water hits the blade and the type of weight. Record students' ideas in the class science journal.
- 8  Brainstorm methods of testing the efficiency of a waterwheel. Explain that students will be testing how quickly the waterwheel lifts the weight. Discuss with students how to make the test fair, for example, by using the same amount of string and using the same weight to test their two waterwheels.
- 9 Introduce the enlarged copy of 'Waterwheel investigation planner' (Resource sheet 7), and read through with students. Model how to choose one variable to investigate and write a question for investigation, for example, 'What happens to the time to lift the weight when we change the number of blades?'. Ask teams to identify how they will keep their test fair, for example:
 - **Change:** the number of blades
 - **Measure:** the time to lift the weight
 - Keep the **same:** the material the blades are made of, the size and shape of the blades, the angle at which the water hits, the length of string and the weight.
- 10  Draw students' attention to the 'Recording results' section of the enlarged copy of 'Waterwheel investigation planner' (Resource sheet 7). Explain that students will test the waterwheel three times. Discuss why it is necessary to perform trials more than once (that is, 'repeat trials'), asking questions such as:
 - Do you think the test will be identical every time?
 - What might change?
 - How might that affect the result?
 - How might that affect our conclusion?

Record students' thoughts in the class science journal. Explain that students will be calculating the average of three trials to account for variations in each test.

- 11** Ask teams to draw an annotated diagram of their waterwheels in their 'Recording results' section of their copy of 'Waterwheel investigation planner' (Resource sheet 7). Discuss the purpose and features of an annotated diagram, and model how to draw one on the enlarged copy of the resource sheet.



Literacy focus

Why do we use an annotated diagram?

We use an **annotated diagram** to show the parts of an object and how they work.

What does an annotated diagram include?

An **annotated diagram** might include an accurate drawing, a title, a date and a few words about each of the parts and how they work. A line or arrow joins the words to the part.

- 12** Form teams and allocate roles. Ask Managers to collect teams' copies of 'Waterwheel procedure' (Resource sheet 6) and 'Waterwheel investigation planner' (Resource sheet 7). Allow time for teams to plan their investigation.
-  **13** Ask Managers to collect team equipment. Allow times for teams to build their waterwheels.
-  **14** Organise for teams to test their waterwheels (see 'Preparation').
- 15** Update the science chat-board. Update the word wall with words and images.

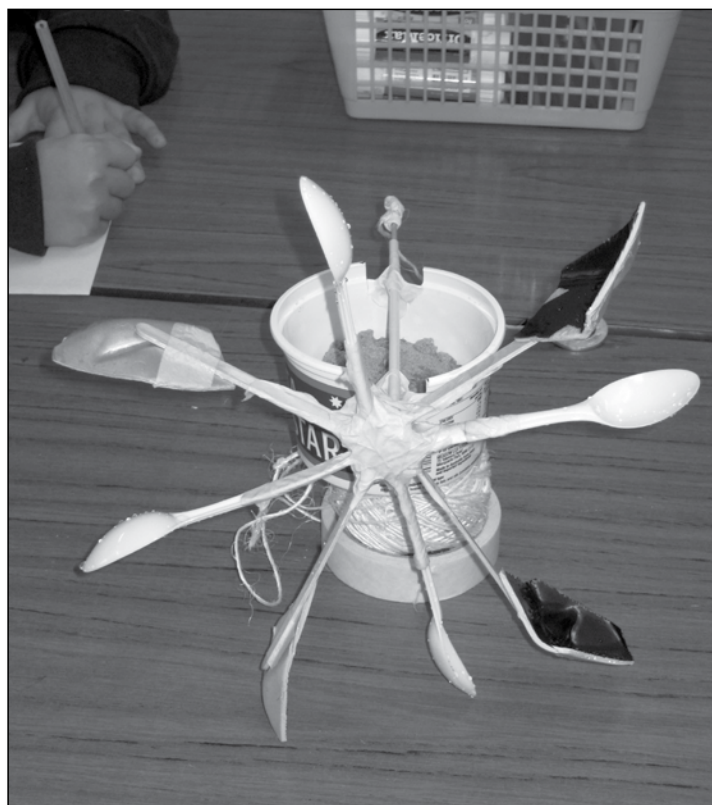

Work sample of a waterwheel

Waterwheel procedure

Aim: To create a waterwheel

Equipment

- 4 wooden skewers
- adhesive tape
- piece of adhesive tac
- 30cm piece of string
- waterwheel blades

Activity steps

1. Tape the four wooden skewers together lengthwise to create an axle.
2. Tie the end of the length of string to the end of the axle where the skewers are blunt.
3. Fix the adhesive tac to the other side of the axle where the skewers are sharp.
4. Insert the blades into the adhesive tac.
5. Tie the other end of the string to a small weight.

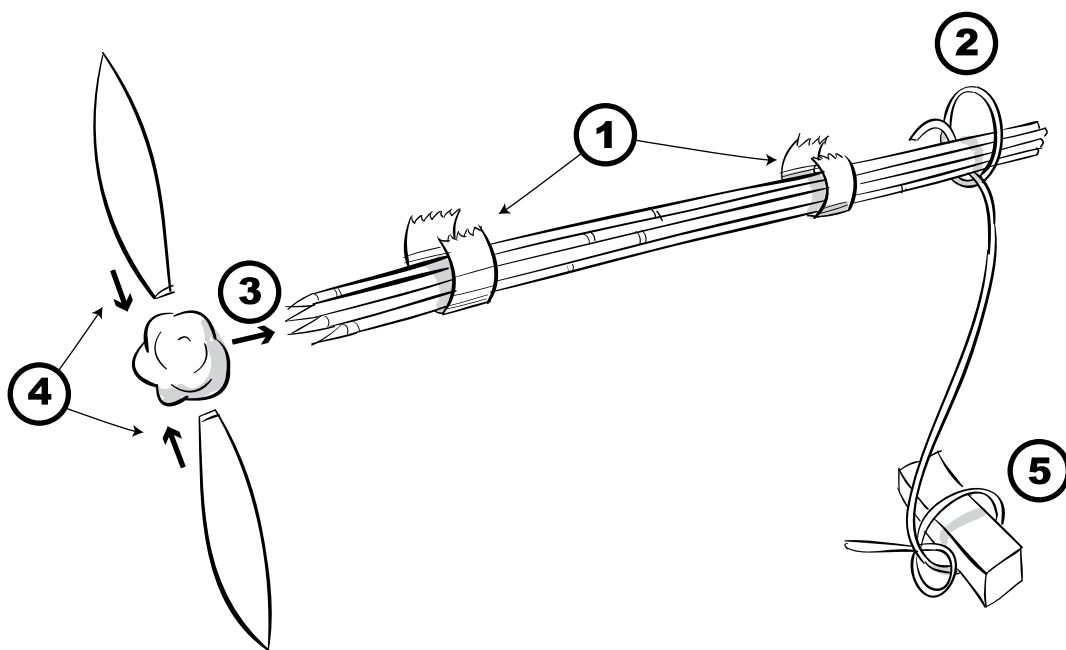

Waterwheel investigation planner

Team members: _____ **Date:** _____

<p>What is your question for investigation?</p> <p>What happens to</p> <p>_____</p> <p>when we change</p> <p>_____?</p>	<p>What do you think will happen?</p> <p>Explain why.</p>
--	---

To make the test fair, what things (variables) are you going to:

Change?	Measure/observe?	Keep the same?
<p>Change only one thing?</p>	<p>What would the change affect?</p>	<p>Which variables will you control?</p>

Describe the blades you will make:

<p>Blades for waterwheel 1:</p>	<p>What you will need:</p>
<p>Blades for waterwheel 2:</p>	<p>What you will need:</p>

Recording results

Waterwheel 1:	Trial	Time
	Trial 1	
	Trial 2	
	Trial 3	
	Average	

Waterwheel 2:	Trial	Time
	Trial 1	
	Trial 2	
	Trial 3	
	Average	

Discussing results

What is your claim to answer your question for investigation?

What is your evidence for the claim? How does your evidence support your claim?

Does your claim match your prediction? Why do you think that is?

Session 2 Winning waterwheels

Equipment



FOR THE CLASS

- class science journal
- word wall
- team skills chart
- team roles chart
- enlarged copy of 'Waterwheel investigation planner' (Resource sheet 7) from Session 1

FOR EACH TEAM

- role wristbands or badges for Director, Manager and Speaker
- each team member's science journal
- copy of 'Waterwheel investigation planner' (Resource sheet 7) from Session 1
- waterwheels from Session 1

Lesson steps

- 1 Review the previous session and explain that in this session students will complete repeat trials of their two waterwheel designs. Review the purpose of repeat trials.
-  2 Reform teams from previous lesson. Ask Managers to collect equipment to conduct the trials and allow time for teams to complete the investigation.
- 3 Introduce the 'Discussing results' section of the enlarged copy of 'Waterwheel investigation planner' (Resource sheet 7). Ask students to complete the section by:
 - writing a claim to answer their original question, for example, 'Having more blades makes a waterwheel more efficient', recording a summary of their evidence and why it supports the claim, for example, 'The waterwheel with more blades lifted the weight faster. As it was a fair test, the number of blades was what made the waterwheel more efficient.'
 - discussing whether their claim matches their original prediction, for example, 'I thought that the waterwheel with more blades would be more efficient and it was. I think this is because the blades catch more of the water that is flowing past.'
-  4 Form teams and allocate roles. Allow time for teams to complete their copy of 'Waterwheel investigation planner' (Resource sheet 7).
- 5 Ask teams to compare their results with other teams in the class, looking for patterns. Ask questions such as:
 - Did other teams find evidence that supports your claim?
 - Do other teams have different claims? Why do you think that is?
 Encourage students to question each other using the 'Science question starters' (see Appendix 5).
-  6 As a class, discuss the investigation, asking questions such as:
 - What variables affect the efficiency of the waterwheels?
 - What did we find that we didn't expect? Why was it surprising?
 - What did we find that confirmed what we thought? What did we learn from that?
 - What went well with our investigation?

- What didn't go well? How could we have done it better?
- What are you still wondering about?

Record students' thoughts in the class science journal.



- 7 Draw a waterwheel being tested in the class science journal, and brainstorm with students what types of energy they can recognise and where energy is being transferred or transformed. For example:
- The water has gravitational energy when it is held up high.
 - This energy is transformed into movement energy as it falls.
 - The movement energy of the water is transferred to movement energy of the axle when it hits the blades. Some movement energy is transformed into sound energy because we can hear it.
 - The movement energy of the axle is transformed into gravitational energy of the weight as the string is wrapped around the axle.

Optional: If students have previously explored friction, for example, through the PrimaryConnections unit *Smooth moves*, discuss how increasing friction within the windmill reduces its efficiency because movement energy is transformed into heat energy.



- 8 Discuss what use waterwheels might have in the local surroundings, asking questions such as:
- Are there rivers in the local area that might have a lot of movement energy?
 - How would a waterwheel affect the biology of a river, for example, disrupting fish swimming or aerating the water?
 - Do rivers always have movement energy?
 - What happens during droughts/floods?
 - What might putting a dam on a river achieve?
 - What kinds of environmental impacts might putting a dam on a river have, for example, flooding, disruption of migration along the river, stable supplies of water for animals?

Record students' answers in the class science journal.

Optional: Access resources to help students with these discussions, for example: www.actew.com.au/education

- 9 Discuss how different civilisations have developed waterwheels for different means (see 'Teacher background information'), and the fact that the waterwheel was probably invented at least twice.



- 10 Ask students to update their individual glossaries and record what they have learned in their science journal. Support students' writing with sentence beginnings such as:
- Today we...
 - What I have learned about energy transfer and transformation is...
 - What I have learned about scientific investigation is...
 - I think it would be useful for STIVS to know...
 - I enjoyed/did not enjoy...
 - I want to know more about...

Optional: Organise for a progress report to be sent to STIVS, either individually or as a class.

- 11 Update the science chat-board. Update the word wall with words and images.

Australian Curriculum links

Science

- Explore more simple energy transfers and transformations.

Asia and Australia's engagement with Asia

- Further explore the invention of waterwheels in China and compare their usage to that of Greco–Roman waterwheels. Identify elements of design that may have come from either culture in modern waterwheels.



Testing a waterwheel

Lesson 5 Domestic help



AT A GLANCE

To support students to represent and explain their understanding of how energy can be transferred or transformed, and to introduce current scientific views about how electricity is generated.

Students:

- create flow charts to show energy transformations and transfers
- read and discuss factual texts about how to generate electricity
- compare the benefits of different energy sources.

Lesson focus

In the *Explain* phase students develop a literacy product to represent their developing understanding. They discuss and identify patterns and relationships within their observations. Students consider the current views of scientists and deepen their own understanding.

Assessment focus



Formative assessment is an important aspect of the *Explain* phase. It involves monitoring students' developing understanding and giving feedback that extends their learning. In this lesson you are looking for evidence that students are developing an understanding about:

- how energy from a variety of sources can be used to generate electricity.

This allows you to provide feedback to help students further develop their understanding.

Key lesson outcomes

Students will be able to:

- draw flow charts representing energy transfer and transformation
- make claims about where energy might have come from
- read and interpret factual texts
- contribute to discussions about how electricity is generated.

This lesson also provides opportunities to monitor the development of students' general capabilities (highlighted through icons, see page 5).

Teacher background information

Sources of energy

The current approximate relative amounts of use of different sources of energy are: oil 38%, coal 26%, gas 23%, hydroelectricity 6%, nuclear 6% and other sources (solar, wind, wave, tidal, geothermal) 1%.

The Sun transforms nuclear energy into electromagnetic radiation due to a process of nuclear fusion. We rely on the Sun for many renewable, secondary energy sources that can be transformed into electricity. For example:

- Plants transform the light energy from the Sun into chemical energy, for example, complex carbohydrates, through the process of photosynthesis.
- Solar panels capture some of the Sun's light energy to transform it into electrical energy.

Other sources of energy include:

- Batteries in which two different chemical reactions take place — one reaction depletes the surrounding fluids of electrons and the other reaction enriches it. When the electron-rich pole of the battery is connected with an appropriate wire to the electron-poor pole of the battery, electrons flow along the wire generating electrical energy.
- Heat that is dissipating from the centre of the Earth (geothermal energy) — one-fifth of the heat comes from the original formation of the Earth, the rest comes from the decomposition of radioactive elements in the Earth's crust.
- Nuclear fission — scientists have found how to split the nucleus of uranium atoms by bombarding them with neutron particles. When the nucleus splits it releases a great deal of energy.

Summary of energy sources that could be used to generate electricity

Energy source	Description	Renewable?	Some considerations of environmental impacts
Fossil fuels	Fossilised remains of organic material, burned to release their stored chemical energy, eg, oil, coal, gas.	Yes, but it would take millions of years to re-create	<ul style="list-style-type: none"> Their combustion releases greenhouse gases and other pollutants. These gases were captured millions of years ago and are new additions to the atmosphere. Filtering systems are being developed to try to reduce emissions. Attempts are being made to capture 'waste heat' to improve efficiency. The fuels need to be mined.
Biomass	Organic material, such as yard clippings, wood, or even municipal solid waste, burned to release stored energy	Yes	<ul style="list-style-type: none"> Their combustion re-releases recently captured greenhouse gases as well as other pollutants. Similar to fossil fuels, filtering systems might be developed. Might promote use of pesticides, chemical fertilisers, etc. Might also promote land clearance and use of agricultural crops for energy production.
Nuclear fusion	Hydrogen atom nuclei combine to form a helium atom nucleus, emitting massive amounts of energy	No	<ul style="list-style-type: none"> We do not yet have a method of using this energy source directly; it is the reaction that occurs in stars, such as our Sun. Hydrogen is one of the most common elements in the solar system.
Nuclear fission	The nucleus of an atom, such as uranium, is split forming two new nuclei releasing a huge amount of energy	No	<ul style="list-style-type: none"> Uranium, the by-product from the reaction, is radio-active and dangerous to life forms. It needs to be transported and stored without risk of contamination. If damaged or not properly maintained, nuclear power plants can become the sources of large-scale radiation fallout or meltdowns. Uranium needs to be mined.
Geothermal	Capturing heat by pumping water through hot rock deep below the Earth's surface	Yes	<ul style="list-style-type: none"> Currently known environmental impacts are very small compared to other types of power generation.
Batteries	A chemical reaction transforms chemical energy into electrical energy when connected in a circuit	No	<ul style="list-style-type: none"> Batteries create waste products that are harmful to living things and need to be disposed of carefully. It also takes energy to make the metal electrodes and other components. Batteries are best for simply storing chemical energy.
Wind and water	Wind and water movement harnessed to turn turbines	Yes, but not always available	<ul style="list-style-type: none"> Dams placed to regulate river flow can flood areas and disrupt river life. The placement of wind farms causes controversy and can harm some flying animals.
Sun	Light energy from the Sun captured through the use of solar panels	Yes, but not always available	<ul style="list-style-type: none"> The creation and upkeep of solar panels, particularly as they require many special metals.

Sustainable energy

The terms sustainable energy, renewable energy, and alternative energy all have slightly different connotations and can be dependent on the context in which they are used.

Broadly speaking, the terms can be described as follows:

- Alternative energy refers to any energy gained from resources that are intended to replace fuel sources with undesirable attributes and/or are currently predominately used.
- Renewable energy refers to energy that is taken from sources which can be replaced.
- Sustainable energy can be defined as the provision of energy that meets the needs of the present without compromising the needs of the future. Energy resources might be said to be sustainable if they can be replaced at the rate that they are used.

There are many sources of information regarding the use of sustainable energy resources. The information provided on websites is influenced by the views of the writer and might be heavily biased. Identifying any bias, such as funding or support, might help to determine whether or not the information is likely to be balanced. It is also important to review several sources of information to check for reliability. These are important skills in research, especially with regard to controversial topics.

One area that needs to be taken into consideration when evaluating the sustainability of different forms of energy production is the materials and energy that are required to make the power plant, turbines or solar panels. Fossil fuels and uranium are indeed mined, but so are the metals required to make renewable energy sources if they are not recycled from elsewhere. Another consideration is how long the machines last and what happens to them when they are no longer useful.

Students' conceptions

Some students might believe that solar panels do not work in winter or in cold places. However, photovoltaic cells capture the radiations of the Sun directly and do not rely on heat for their processes. In fact, they are more efficient at lower temperatures. They produce less power in winter because there is less sunlight.

Students might hold non-scientific ideas about energy transfer or transformation, thinking that each form of energy is an entity that is not related to other forms of energy, ie light is light and heat is heat, and they do not interact.

Students might not have any concept of the ways electricity is generated in power plants, especially the similarities in the way power plants work. The factor that differs most is the energy source rather than the process of generating electricity itself.

Students might believe that all forms of renewable energy are 'good' and all forms of non-renewable energy are 'bad' due to the media coverage of the issue. In fact, there are positive and negative consequences to all the processes for harnessing energy for the use of a growing population in the world.

Equipment

FOR THE CLASS

- class science journal
- class science chat-board
- team roles chart
- team skills chart
- 1 enlarged copy of 'Where does electrical energy come from?' (Resource sheet 8)
- 'Request for scientific support' (Resource sheet 1) from Lesson 1
- collection of multimedia resources (see 'Preparation')

FOR EACH TEAM

- role wristbands or badges for Director, Manager and Speaker
- each team member's science journal
- 1 copy of 'Where does electrical energy come from?' (Resource sheet 8)

Preparation

- Identify multimedia resources, including books, photos and videos, to help students investigate how electricity is generated, transported and used.
- Prepare an enlarged copy of 'Where does electrical energy come from?' (Resource sheet 8).
- *Optional:* Display 'Where does electrical energy come from?' (Resource sheet 8) on an interactive whiteboard or a computer connected to a projector. Check the PrimaryConnections website to see if an accompanying interactive resource has been developed: www.science.org.au/primaryconnections

Lesson steps



- 1 Using the previous lesson's five sections of the class science chat-board review how much students have learned in response to the questions from STIVS.
- 2 Discuss what students have learned about energy transformation and transfer. Explain that energy is not created or destroyed; it is only transferred or transformed into another type of energy.
Optional: If the class wrote progress updates to STIVS at the end of Lesson 4, organise to receive a letter that explains this and asks students to use pictures to help their team understand what is happening. The letter could also request further information of how electrical energy is generated.
- 3 Explain that students will be working in collaborative learning teams to create flow charts of the energy transfers and transformations that they have studied to send to STIVS. Discuss the purpose and features of a flow chart.

Literacy focus

Why do we use a flow chart?

We use a **flow chart** to describe a sequence of events or the stages in a process.

What does a flow chart include?

A linear **flow chart** organises events or stages in a line. Arrows are used to indicate the sequence in which they occur.

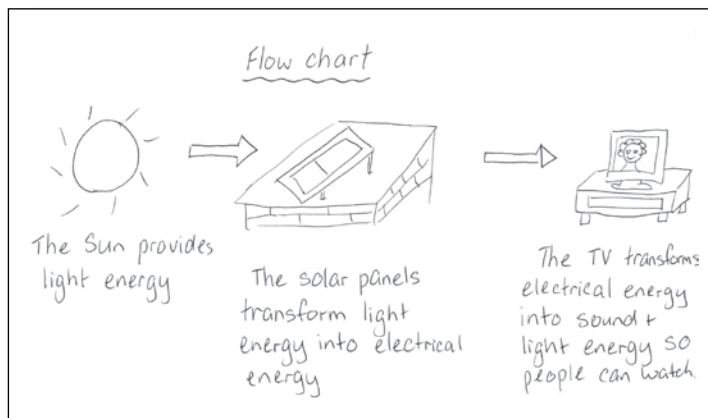

Work sample of flow chart of energy transfers and transformations



- 4 Ask teams to make their flow chart more complete by imagining energy transfers that might happen after what they saw, for example, 'The movement of the energy of the windmill transformed into gravitational energy when the weight was lifted. The string was cut and the stone fell, transforming gravitational energy into movement energy. The weight fell on a grain of wheat and crushed it, transforming movement energy into deformation energy'.



- 5 Form teams and allocate roles. Allow time for teams to complete the activity.



- 6 Ask Speakers to share their ideas with the class. As a class, discuss the 'end points' or the ultimate sources of energy (see 'Teacher background information').
- 7 Explain that students will read a text that explains how electrical energy is generated. Ask students, as a class or individually, to read through the factual text 'Where does electrical energy come from?' (Resource sheet 8), highlighting key words and ideas. Discuss the purpose and features of a factual text.



Literacy focus

Why do we use a factual text?

We use a **factual text** to teach or persuade someone reading it. We can use a **factual text** to collect information.

What does a factual text include?

A **factual text** includes a heading, writing and pictures. It might include labels, graphs, maps and photographs.

- 8 Discuss the terms that students have highlighted in ‘Where does electrical energy come from?’ (Resource sheet 8). Add each word, with a brief description if necessary, to the word wall section of the class science chat-board.
-  9 Discuss what students have learned about how electrical energy is generated. Ask students questions such as:
- What types of energy can be transformed into electrical energy?
 - How can types of energy be transformed?
 - Can you add extra steps in your flow charts? Which ones?
 - Which sources of energy are renewable? Why do you think that?
 - Which sources of energy are sustainable? Why do you think that?
 - What are you are still wondering about?
- Record students’ thoughts on the class science chat-board, adding any new information they might have.
-  10 Introduce the reference materials and explain that students can consult them to answer some of the questions they have. Remind students to add new claims, supported with evidence, on the class science chat-board.
-  11 Review the ‘Request for scientific support’ (Resource sheet 1) from Lesson 1 (see ‘Preparation’), and explain that the class will be examining possible answers to the remaining questions in the next lesson.
- 12 Update the science chat-board. Update the word wall with words and images.

Australian Curriculum links

Science

- Investigate how solar energy is harnessed using photovoltaic cells or used to heat, cool and ventilate a building, for example, view the *New Inventors* clip about the ‘Solamate’ system.

Where does electrical energy come from?

The electrical energy we use is generated by power stations. Most power stations in Australia burn fossil fuels, usually coal, to generate energy. Coal is burnt to release heat energy that heats water. The water turns into steam. The steam rushes past turbines (devices with blades), which then spin. The turbines are connected to generators. As the turbines spin, wires or magnets in the generators spin transforming movement energy into electrical energy.

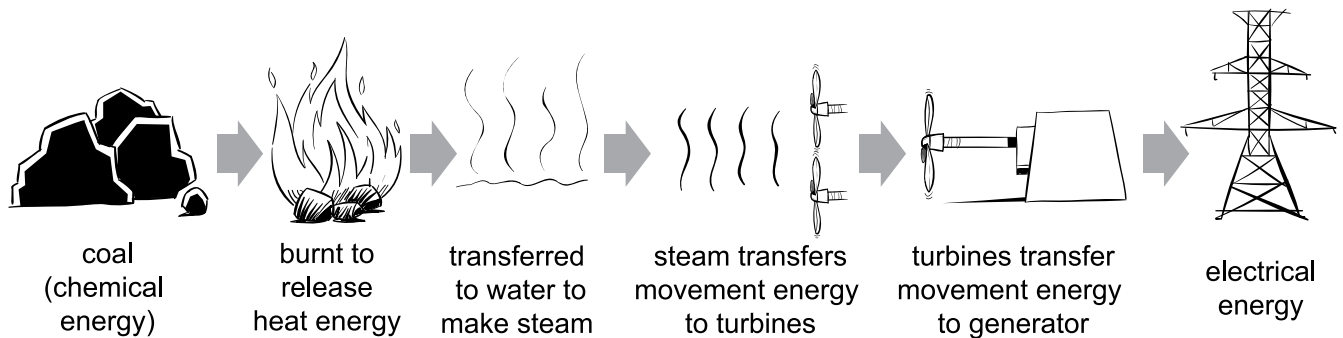

Flow chart of how coal is converted to electrical energy inside a power station

How does electrical energy get to our homes?

Power stations that produce electricity are usually a long way from places that use it. To get to those places, the electrical energy goes through a lot of steps before it reaches our homes and factories:

- After being produced in the **power station**, lots of electrical energy is transferred along **high voltage transmission lines** to local **substations**.
- These **substations** use **power poles** to distribute electrical energy to places around them.
- The electrical energy goes through a **transformer drum** before reaching your house so that it is the right voltage for your appliances to use safely

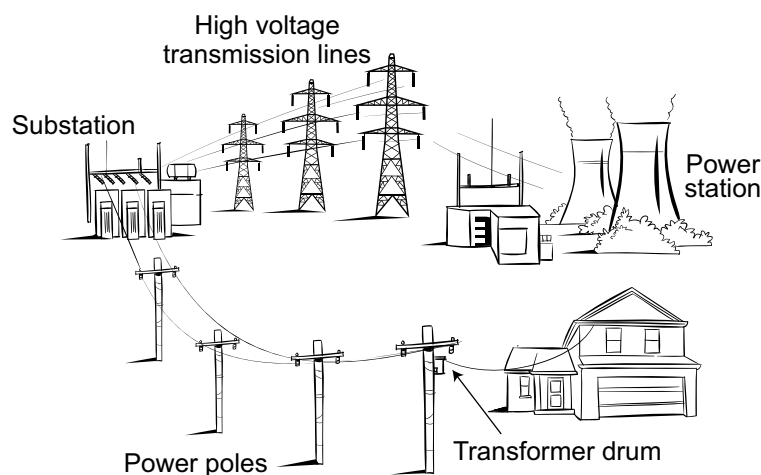

Other sources of energy

Hydroelectric power stations do not burn fuel. They use water falling from great heights (movement energy) to turn the large vanes of water turbines connected to a generator.

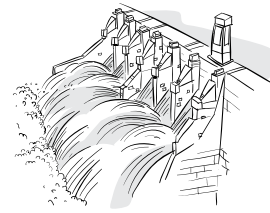

Wind turbines use the movement energy of the wind to turn their huge turbines connected to a generator.

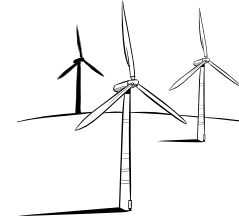

Solar panels generate electricity without turbines. Light energy from the Sun falls on special cells on the panels. These transform the light energy into electrical energy.

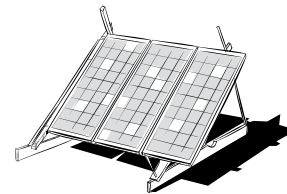

Batteries do not use turbines either; they directly transform certain types of chemical energy into electrical energy once they are connected in a circuit.

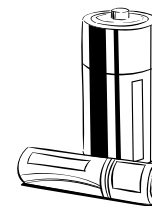

The energy challenge

Most homes rely on electrical energy provided from power stations. Every time you plug something into a power point, the energy you are using probably came from a lump of coal, some gas or some moving water from a long way away!

Fossil fuels won't last forever (they are non-renewable), and burning them can produce waste products that can damage the environment. Renewable sources of energy, such as water, wind and solar, can present new issues, such as high costs and requiring large areas of land. The challenge for the future is to find a way to meet our electrical energy needs which is both friendly on our environment and is at an affordable price.

Lesson 6 Necessary energy

AT A GLANCE

To support students to represent their understanding of how and why electrical energy is used in the home and to introduce current scientific views about sustainable energy sources.

Students:

- present the results of their investigations about the use of appliances
- identify what electricity is used for in households and how it is used.

Lesson focus

In the *Explain* phase students develop a literacy product to represent their developing understanding. They discuss and identify patterns and relationships within their observations. Students consider the current views of scientists and deepen their own understanding.

Assessment focus



Formative assessment is an important aspect of the *Explain* phase. It involves monitoring students' developing understanding and giving feedback that extends their learning. In this lesson you are looking for evidence that students are developing an understanding about:

- how electrical circuits provide a means of transferring and transforming electricity.

This allows you to provide feedback to help students further develop their understanding.

Key lesson outcomes

Students will be able to:

- identify how electricity is used in the home
- contribute to discussions about how often different appliances are used and whether they are necessary
- participate in creating a factual letter including evidence-based claims.

This lesson also provides opportunities to monitor the development of students' general capabilities (highlighted through icons, see page 5).

Equipment

FOR THE CLASS

- class science journal
- class science chat-board
- team roles chart
- team skills chart
- 1 enlarged copy of 'Measuring mayhem' (Resource sheet 9)
- 'Request for scientific support' (Resource sheet 1) from Lesson 1
- materials to write letter to STIVS (see 'Preparation')

FOR EACH TEAM

- role wristbands or badges for Director, Manager and Speaker
- each team member's science journal
- each team member's completed 'Auditing appliances' (Resource sheet 4, see Lesson 2, Session 2)
- 1 copy of 'Measuring mayhem' (Resource sheet 9) per team member

Preparation

- Decide how students will respond to the initial request from STIVS if they have not been in regular correspondence with them, for example, organise for the courier from Lesson 1 to arrive and ask for a progress update. Decide how to compose the letter, either as a class or in teams.
- *Optional:* Display 'Measuring mayhem' (Resource sheet 9), and compose a class letter/email on an interactive whiteboard or a computer connected to a projector. Check the PrimaryConnections website to see if an accompanying interactive resource has been developed: www.science.org.au/primaryconnections

Lesson steps



- 1 Review the previous lessons and ask students to report the results of their home investigations if they have not yet done so. Ask questions such as:
 - Why do we connect houses to electric power lines?
 - What is electricity used for in the house?
 - What is electricity used for in the neighbourhood?
 - How many machines would be affected if we no longer had electricity?

Record students' thoughts in the class science journal.

- 2 Introduce the enlarged copy of 'Measuring mayhem' (Resource sheet 9). Explain that students will be filling out a table for each appliance they have identified at home. Discuss the terms on the sheet:
 - **Energy types produced** refers to the types of energy the appliance transforms electrical energy into
 - **Rate of use** refers to how often it is used in a week in the home
 - **Necessity** refers to whether people really need it.





Add the terms to the word wall section of the class science chat-board, with a description if necessary.

- 3 Model filling in an entry on the enlarged copy of 'Measuring mayhem' (Resource sheet 9).

Appliance: toaster

Use	Energy types produced
Rate of use: 1 (low) - 2 - 3 - <u>4</u> - 5 (high)	Energy types produced <u>heat + light</u> Notes: <u>It gets used about 10 mins every day.</u>
Necessity: 1 (low) - 2 - 3 - <u>4</u> - 5 (high)	Notes: <u>If we didn't have a toaster we we would have to eat just bread,</u>

Work sample of 'Measuring mayhem'

- 4 Form teams and allocate roles. Ask Managers to collect three copies of 'Measuring mayhem' (Resource sheet 9) for their team. Discuss how teams can therefore fill in entries for up to nine machines.
-  5 Allow time for teams to complete their resource sheets.
-  6 Ask teams to share their results with another team in the class to identify similarities and differences in their thinking.
-  7 As a class, discuss what students have learned, asking questions such as:
- Which machines are used often? Did we all have similar responses for this? Why?
 - Which machines are most necessary? Did we all have similar responses for this? Why?
 - What would people do if those machines were no longer working?
 - Which machines could people easily do without?
 - What do you think would happen if your house had no electricity for several days?
 - What do you think would happen if your house had no electricity for several weeks?
- Optional:* Investigate news stories about real life events when areas have had electricity sources removed.
-  8 Introduce the 'Request for scientific support' (Resource sheet 1) from Lesson 1 (see 'Preparation'). As a class, compose an answer to STIVS' five initial questions. Ask questions such as:
- What have we learned?
 - What can we claim? Are we sure of our claim? What is our evidence to support our class?
- Note:** If students have been composing regular updates to STIVS, this letter would only need to contain information gathered during the *Explain* phase.
- 9 Update the science chat-board. Update the word wall with words and images.

Measuring mayhem

Name: _____ Date: _____

Appliance: _____

Use	Energy types produced
Rate of use: 1 (low) – 2 – 3 – 4 – 5 (high)	Notes:
Necessity: 1 (low) – 2 – 3 – 4 – 5 (high)	Notes:

Appliance: _____

Use	Energy types produced
Rate of use: 1 (low) – 2 – 3 – 4 – 5 (high)	Notes:
Necessity: 1 (low) – 2 – 3 – 4 – 5 (high)	Notes:

Appliance: _____

Use	Energy types produced
Rate of use: 1 (low) – 2 – 3 – 4 – 5 (high)	Notes:
Necessity: 1 (low) – 2 – 3 – 4 – 5 (high)	Notes:

Lesson 7 Full of potential

AT A GLANCE

To support students to plan and conduct an investigation of how to generate electricity using simple household items.

Students:

- make a simple battery following a procedural text
- work in collaborative learning teams to plan and conduct an investigation to determine the effect of a chosen variable on the functioning of their battery
- observe, record and share the results of their investigation.

Lesson focus

In the *Elaborate* phase students plan and conduct an open investigation to apply and extend their new conceptual understanding in a new context. It is designed to challenge and extend students' Science Understanding and Science Inquiry Skills.

Assessment focus



Summative assessment of the Science Inquiry Skills is an important focus of the *Elaborate* phase. Rubrics are available on the website to help you monitor students' inquiry skills.

Key lesson outcomes

Students will be able to:

- write a question for investigation and predict what will happen when a variable is changed
- work in collaborative learning teams to plan and safely conduct an investigation about variables that affect a simple battery
- record their results in a table
- make evidence-based claims about their results
- compare their results with their predictions and with other teams' results
- evaluate their investigation
- discuss and compare this method of electricity production with other methods.

This lesson also provides opportunities to monitor the development of students' general capabilities (highlighted through icons, see page 5).

Teacher background information

Plant material

In this lesson, students will be creating a battery with plant material, for example, lemons or potatoes. The term 'plant material' has been chosen because 'fruit' has a specific meaning in biology — it refers to the product of a flower and therefore includes things such as bean pods and tomatoes. The term 'vegetable' is not a scientific term; it refers to many different types of edible plant material and depends on culinary and cultural tradition.

Batteries in general

Batteries are a common way of transporting and storing energy. When the positive and negative terminals of batteries are connected into an electrical circuit, the battery 'pushes' electrons around the circuit creating electrical energy.

The positive and negative terminals are generally made from two different metals that are surrounded by a solution called an electrolyte (a salt or acid solution). The metals react with the electrolyte surrounding them.

- The chemical reaction that takes place at the negative terminal produces extra electrons
- The chemical reaction at the positive terminal requires electrons.

Therefore, there is a net electron difference between the terminals, known as potential difference. When the terminals are connected with a wire creating a circuit, the electrons are 'pushed' from the negative terminal with excess electrons to the positive terminal which

requires electrons, transforming the chemical energy into electrical energy. If a device, such as a light bulb, is placed in the circuit the electrical energy can be transformed into other forms of energy, such as light and heat.

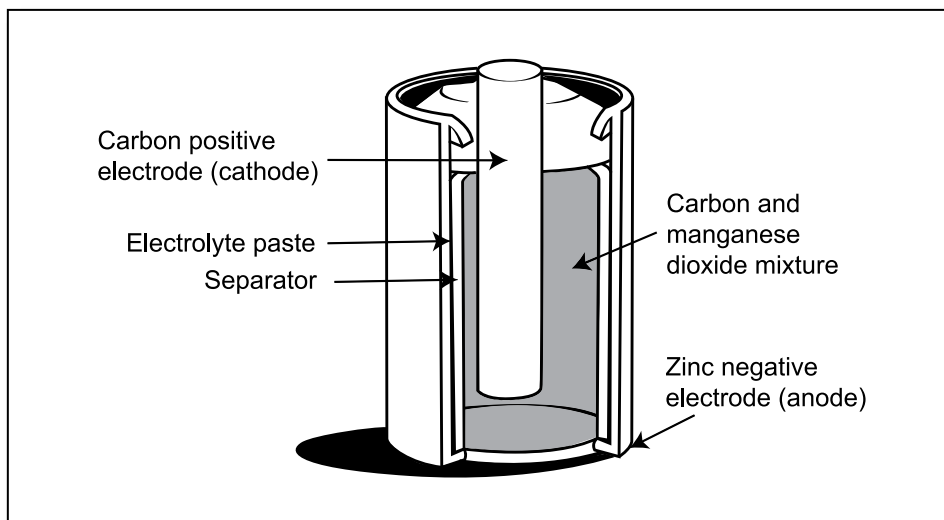

Cutaway diagram of a battery



Do not cut open batteries in the classroom or encourage students to do this because the substances they contain are dangerous and corrosive.

By scientific convention, electrical 'current' is said to flow from the positive terminal of a battery to the negative terminal. This is due to a historical decision made before scientists knew that electrons moved from the negative terminal towards the positive terminal (in the opposite direction to the 'current').

A battery is 'flat' when there are no more substances with which to create the reactions at the positive terminal (anode) and the negative terminal (cathode). Rechargeable batteries have anodes and cathodes whose reactions can be reversed if they receive energy in the form of electricity.

Plant material batteries

Students can make a simple battery using plant materials that contain acids, for example, lemons (citric acid) or potatoes (phosphoric acid). The acid in the plant material serves as the electrolyte.

Both copper and zinc have the potential to be oxidized, that is, to release electrons and positive ions. Of the two, zinc is more able to release its electrons, which is why it becomes the negative terminal and the copper becomes the positive terminal.

The electrons therefore move from zinc to copper through the electrical circuit.

The metals must not be in contact with each other, but both need to be in contact with the electrolyte. The electrical output will depend on the ability of the metals to react with the acid, and the amount and strength of acid.

The output of the battery, which is usually about 1 volt, can be increased by joining the negative terminal (zinc) of one battery to the positive terminal (copper) of another with plant material. Joining two pieces of plant material in this way is called 'putting them in series'. A series can have as many pieces of plant material as you like, as long as they are always connected anode to cathode.

Equipment

FOR THE CLASS

- class science journal
- word wall
- team skills chart
- team roles chart
- two AA batteries
- two pieces of insulated wire with alligator clips or strip 2 cm of insulation off ends of wire
- 1 small light globe that can be connected to an AA battery, eg, a torch light globe
- enlarged copy of 'Generating electricity' (Resource sheet 10)
- enlarged copy of 'Battery procedure' (Resource sheet 11)
- enlarged copy of 'Battery investigation planner' (Resource sheet 12)

FOR EACH TEAM

- role wristbands or badges for Director, Manager and Speaker
- each team member's science journal
- 1 copy of 'Battery procedure' (Resource sheet 11)
- 1 copy of 'Battery investigation planner' (Resource sheet 12)
- 2 pieces of copper (see 'Preparation')
- 2 galvanised nails (see 'Preparation')
- 2 lemons or potatoes
- 3 pieces of insulated wire with alligator clips or strip 2 cm of insulation off ends of wire
- 1 voltmeter or small LED light globe with two wires
- materials to make modifications to their battery (see 'Preparation')

Preparation

- Prepare an initial battery pack for teams including:
 - two lemons or potatoes
 - one piece of insulated wire with alligator clips or stripped so the internal metal is available to be wrapped around the nail and copper
 - two pieces of copper, for example, copper wire with the insulation stripped or copper coins
 - two steel nails, preferably galvanised (covered with zinc), or two pieces of zinc
 - one voltmeter for students to measure current with or a small LED light with wires attached.
- Collect other materials for students to modify one variable of their battery, for example:
 - extra packs of materials to add more lemons or potatoes in the series
 - different plant material, for example, carrots, sweet potatoes, bananas, oranges and apples
 - different metals, for example, non-galvanised nails and aluminium.
- Enlarge a copy of 'Generating electricity' (Resource sheet 10), 'Battery procedure' (Resource sheet 11) and 'Battery investigation planner' (Resource sheet 12).
- *Optional:* Display 'Generating electricity' (Resource sheet 10), 'Battery procedure' (Resource sheet 11) and 'Battery investigation planner' (Resource sheet 12) on an interactive whiteboard or a computer connected to a projector. Check the PrimaryConnections website to see if an accompanying interactive resource has been developed: www.science.org.au/primaryconnections

Lesson steps

- 1 Introduce a letter received from STIVS after sending the progress report. Introduce the enlarged copy of 'Generating electricity' (Resource sheet 10) and 'Battery procedure' (Resource sheet 11). Read with the class and discuss any challenging words or phrases, and add them to the word wall section of the class science-journal.

Note: The term 'plant material' is used because the terms 'fruit' and 'vegetable' have different meanings in science (see 'Teacher background information').



- 2 Introduce an AA battery and discuss with students what they know about batteries and what they are used for. Ask students how to connect the battery to an electric circuit to make a light globe glow.
- 3 Demonstrate how to create an electric circuit using the one battery, the two wires and the light globe. Discuss the importance of connecting 'positive' terminals to 'negative terminals' if an appliance has them. Ask students if they have ever put batteries the wrong way into appliances and what happened when they did (nothing happened since a circuit was not created and the electrical energy couldn't flow).
- 4 Draw a picture of the completed electric circuit on the board.

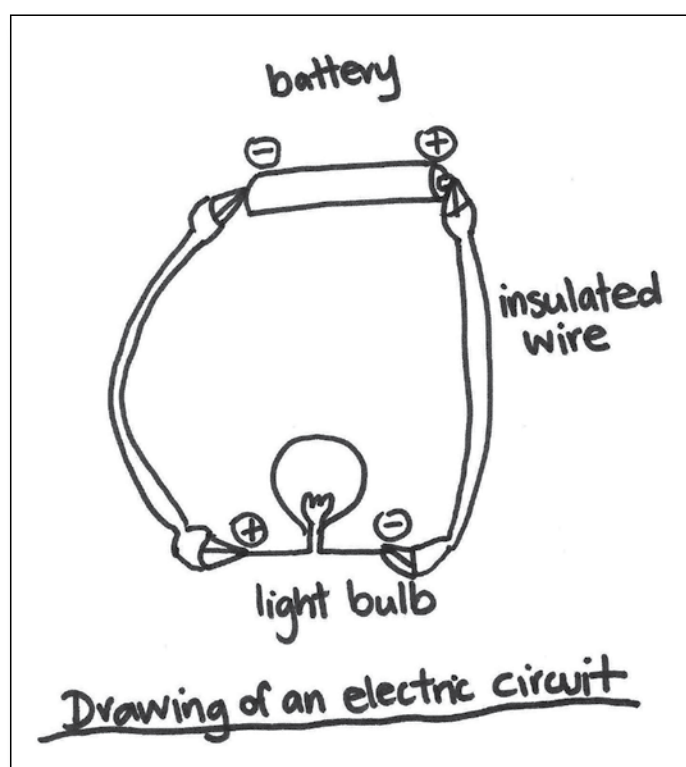

Sample of a drawing of an electric circuit

- 5 Introduce the second AA battery and ask students why two batteries might be used in an electric circuit (to provide more power). Ask students how they might add the second battery into the circuit that is drawn on the board. Discuss how batteries can be placed in a series and discuss how the lemon battery on 'Battery procedure' (Resource sheet 11) is two lemon 'batteries' in series.



Remind students that providing too much electricity for a device, for example, a light globe, is dangerous and to proceed with caution if linking batteries together in a series.

- 6 Introduce the equipment table and the materials for students to work in collaborative learning teams to follow the procedural text provided by STIVS.
- 7 Model how to use a voltmeter, if they are available, or how to hook up an LED light to make a complete circuit. Discuss how to read a voltmeter or check if the LED is operating, for example, by shading it so that a feeble light is visible despite strong daylight. The LED has a positive and negative side so needs to be connected correctly.

Note: The higher the voltage, the stronger the light of the LED.

- 8 Form teams and allocate roles. Ask Managers to collect team equipment.



- 9 Allow time for teams to construct their battery.

Note: The amount of electricity generated will depend on factors such as the amount of acidity in the plant material. If batteries are not lighting a 2V light globe, students might have mis-wired it or there might be a faulty connection. If that is not the case, students might need to add some extra plant material in the series, for example, by adding another lemon or potato. The wires should always connect two different types of material. Ask students to increase the number gradually, otherwise the battery may provide too much electricity and damage the bulb.



- 10 As a class, discuss what students have observed while making their battery. Brainstorm variables that might affect the amount of energy the battery generates, for example, the type of plant material, the number of pieces of plant material, the type of metal involved, the amount of metal, the temperature of the plant material or the temperature of the room. Record students' ideas in the class science journal.

- 11 Introduce the enlarged copy of 'Battery investigation planner' (Resource sheet 12) and explain that students will be working in collaborative learning teams to plan and conduct a fair test of what makes the best battery. Discuss the meaning of 'best'.



- 12 Review with students how to write a question for investigation by choosing one variable to investigate, for example, 'What happens to the electricity generated by the battery when we change the type of plant material?'. Remind teams to keep their test fair, for example:

- **Change:** one variable, for example, the type of plant material
- **Measure/observe:** the volts/the brightness of the LED light
- Keep the **same:** the number of pieces of organic material, the types of metal, the amount of metal.



- 13 Discuss with students how to record their results, depending on which variable they choose. Ask students to draw a table to record their results in their science journal.



- 14 Ask Managers to collect their team's copy of 'Battery investigation planner' (Resource sheet 12). As teams are planning, ask questions such as:

- Have you thought about...?
- That's interesting! Can you tell me more about...?
- Is there another way...?

- 15 Ask Managers to collect their teams' equipment. Allow time for teams to modify their battery and record their results.



16 Ask Speakers to share their teams' results. Ask questions such as:

- What was your question for investigation?
- What is your claim to answer that question?
- What is your evidence for the claim?
- Why does your evidence support your claim?
- Does your claim match your prediction? Why do you think that is?

Encourage students to question each other using the 'Science Question starters' (see Appendix 5).



17 As a class, discuss the investigation, asking questions such as:

- What variables affect the functioning of the battery?
- What did we find that we didn't expect? Why was it surprising?
- What did we find that confirmed what we thought? What did we learn from that?
- What went well with our investigation?
- What didn't go well? How could we have done it better?
- What are you still wondering about?

Record students' thoughts in the class science journal.



18 As a class, compose an answer to STIVS, asking questions such as:

- What can we claim about the battery?
- Given that the battery we created only lights up a small LED, would we recommend it as a way of producing electricity? Why or why not?
- Would you consider this a renewable and/or a sustainable energy source? Why or why not?
- What other sources of energy could we suggest?

19 Update the science chat-board, including the word wall, with words and images.



Generating electricity

Dear Live Wires

Thank you for the information that you have provided. It has helped us to make sense of our evidence. It seems that the dastardly pair of villains were planning to transform your town's electrical energy into another type of energy. This would mean that no more electricity would be transferred to the town and all the appliances that you have identified would no longer be able to work. While those appliances might or might not be necessary, people rely on them. We are re-doubling our efforts to stop them.

Given the clues you provided, Electric Boy staked out the local power plant and managed to catch the pair before they caused any problems. However, they managed to escape and we have reports they plan to steal the town's supply of batteries.



Just in case, could you please investigate some methods of storing electricity in the home? It would reassure us to know that you have an emergency back-up supply of energy if they managed to momentarily stop electricity reaching your town.

We have attached a procedural text for creating batteries out of plant material. This could be a useful place to start investigations.

Thank you again for your generous offer to assist us in this inquiry. Your support so far has been much appreciated.

Sincere salutations
Ima Constable
Chief Investigator, STIVS

Battery procedure

Aim: To construct a battery using everyday household items

Equipment

- 2 pieces of copper
- 2 nails coated in zinc
- 2 lemons (or other pieces of plant material, such as potatoes)
- 3 pieces of insulated wire with alligator clips or 2 cm of insulation removed from ends
- 1 voltmeter or small LED light globe with two wires

Activity steps

1. To create a positive terminal insert a piece of copper into each lemon.
2. To create a negative terminal insert a nail coated with zinc into each lemon. Do not put it near the copper as the two metals must not touch.
3. Join one end of a piece of insulated wire to one of the pieces of copper, either using the clip or by attaching the non-insulated end.
4. Join the other end of the wire to the nail coated in zinc in the **other** lemon.
5. Your battery is now ready. Test it using the lemon battery, insulated wires and globe (or voltmeter) to make a circuit.

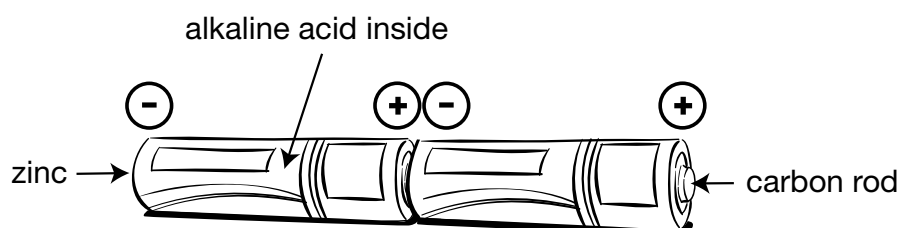
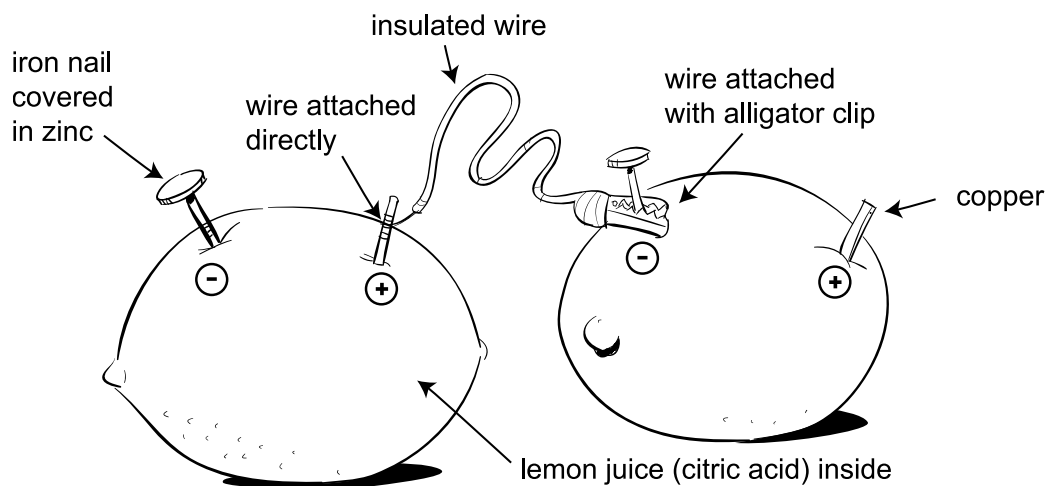

Lemon battery compared to AA batteries

Battery investigation planner

Team members: _____ Date: _____

<p>What is your question for investigation?</p> <p>What happens to</p> <p>_____</p> <p>when we change</p> <p>_____?</p>	<p>What do you think will happen?</p> <p>Explain why.</p>
--	---

To make the test fair, what things (variables) are you going to:

Change?	Measure/observe?	Keep the same?
<p>Change only one thing?</p>	<p>What would the change affect?</p>	<p>Which variables will you control?</p>

Describe what you could change about the battery to generate more electricity:

<p>Annotated drawing of the new battery:</p>	<p>What you will need:</p>
---	-----------------------------------

Lesson 8 Community choices

AT A GLANCE

To provide opportunities for students to represent what they know about how energy from a variety of sources can be used to generate electricity, and to reflect on their learning during the unit.

Students:

- review and reflect on their learning during the unit
- read and discuss a propaganda text
- discuss the role of scientists and scientific information in society
- create texts to communicate what they have learned.

Lesson focus

In the *Evaluate* phase students reflect on their learning journey and create a literacy product to re-represent their conceptual understanding.

Assessment focus



Summative assessment of the Science Understanding descriptions is an important aspect of the *Evaluate* phase. In this lesson you will be looking for evidence of the extent to which students understand that:

- energy from a variety of sources can be used to generate electricity.
- electrical circuits provide a means of transferring and transforming electricity.

Literacy products in this lesson provide useful work samples for assessment using the rubrics provided on the Primary**Connections** website.

Key lesson outcomes

Students will be able to:

- discuss a propaganda text and assess its scientific claims
- identify that science and culture interact to influence personal and community choices
- create multimedia texts and/or presentations to communicate what they have learnt during the unit, supporting claims with evidence
- contribute to discussions and express their opinions about their learning journey.

This lesson also provides opportunities to monitor the development of students' general capabilities (highlighted through icons, see page 5).

Teacher background information

The role of scientists in society

Scientific knowledge is a set of explanations made by scientists based on observations and evidence, which have been built up over time in an attempt to explain how the world works. These explanations continue to be revised as new evidence emerges. Scientists are often careful to point out the limits of the applicability of their research and state when they are uncertain. An important feature of science is that it makes predictions that can be tested by observation and experiment. These tests cannot prove a theory to be correct but they can prove it to be wrong. If the tests agree with the predictions, then the underlying science can be regarded as 'reliable knowledge'.

However, scientific facts might be presented out of context or incompletely, which can be misleading. Facts stated out of context can lead to incorrect assumptions. For example, the association of 'pollution has harmful effects on the environment' and 'some forms of generation of electrical energy can be polluting' might lead to the conclusion that the generation of electricity is the root cause of pollution in the world. As the centuries-old soot on buildings in Europe attest, the burning of fossil fuels and related atmospheric pollution were a problem long before this was used to generate electricity.

Scientific knowledge can influence personal and community choices, for example, it can identify the probable environmental impacts of a decision. However, it is communities and people that ultimately make the choice. Those choices influence which avenues of inquiry scientists choose to pursue, for example, increased interest in alternative sources of energy will increase the number of scientists working on them.

The energy debate

The provision of energy to make changes that we desire always involves some impact on the environment. The burning of a dead tree for warmth in winter removes it from the environment where it might have served as a habitat and source of food for a variety of living things. Depending on the source of energy and the way in which it is used, the impact on the environment can be small or large, and positive or negative.

A key issue in the debate on energy is the amount of energy people are using. This varies across the world, and can be estimated using ecological footprint calculators. These calculators vary in complexity and aim to compare the impacts that different activities might have, for example, choosing to purchase locally grown produce. Many people's lifestyles use substantial amounts of energy. Currently, most of the world's energy is sourced from stocks of energy deposited millions of years ago (fossil fuels), which are not being replenished very quickly. As these sources of energy are not infinite, people are concerned about how to meet energy needs in the future.

A further issue in the energy debate is 'clean' energy, or ensuring that energy transfers and transformations do not pollute the environment. The combustion of fuels, such as fossil fuels, can release substances into the air, including carbon dioxide which is a greenhouse gas. Carbon dioxide remains in the atmosphere where it increases solar absorption and so raises the air temperature, or is partly cleared to the ocean, where it increases acidity. The pollution released can cause 'acid rain' if its concentration is very high. Techniques exist to collect these substances before they are released into the environment, but they are expensive. Many pictures of power stations show large clouds rising from concrete structures. This is steam being released. Gases such as carbon dioxide are generally released from high narrow towers and aren't visible.

Alternative sources of energy, such as solar and wind power, also have impacts on the environment. As with any technology, the decision to use them requires a full environmental impact study, including the impacts of mining materials used to make the machines, impacts of energy used in production of the machines and the impacts of disposing of old machines.

Equipment

FOR THE CLASS

- class science journal
- class science chat-board
- 1 enlarged copy of 'Successful conclusion' (Resource sheet 13)
- 1 enlarged copy of 'Certificate of Appreciation' (Resource sheet 14)
- 1 enlarged copy of 'Propaganda for Short Circuit' (Resource sheet 15)

FOR EACH TEAM

- each team member's science journal
- 1 copy of 'Propaganda for Short Circuit' (Resource sheet 15)

Preparation

- Enlarge a copy of 'Successful conclusion' (Resource sheet 13), 'Certificate of Appreciation' (Resource sheet 14) and 'Propaganda for Short Circuit' (Resource sheet 15). Fill the class name on the enlarged copy of 'Certificate of Appreciation' (Resource sheet 14).
- *Optional:* Organise for each student to receive a personalised 'Certificate of Appreciation' (Resource sheet 14).
- *Optional:* Display 'Successful conclusion' (Resource sheet 13) and 'Propaganda for Short Circuit' (Resource sheet 15) on an interactive whiteboard or a computer connected to a projector. Check the PrimaryConnections website to see if an accompanying interactive resource has been developed: www.science.org.au/primaryconnections

Lesson steps

- 1 Review the unit using the science chat-board and the class science journal. Discuss how the investigation for STIVS has progressed. Ask questions such as:
 - What have we learned?
 - What are you still wondering about?
 - How could we improve our investigation next time?
 - How could we improve our collaborative work?
- 2 Explain that you received another letter from STIVS. Introduce the enlarged copy of 'Successful conclusion' (Resource sheet 13), 'Certificate of Appreciation' (Resource sheet 14) and 'Propaganda for Short Circuit' (Resource sheet 15). Read the covering letter with the class and discuss.
- 3 Explain that students will be reading a piece of propaganda that Short Circuit wrote about his activities. Ask students to share their ideas about propaganda and what it is used for. Ask questions such as:
 - What kind of information might be found in a piece of propaganda (for example, some scientific information might be present to give credibility)?
 - Why are such texts written (for example, to change people's opinions)?
 - How is science information used to represent a point of view (for example, some information might be correct, but the interpretation might be questionable)?
 - Why has Short Circuit chosen to draw a comic-book style for his propaganda (for example, because he wants to portray himself as a superhero)?
- 4 Organise students to read 'Propaganda for Short Circuit' (Resource sheet 15) as an independent reading task in teams or guided reading groups.
- 5 Support students to reflect critically on the piece of propaganda, using questions such as:
 - Do you think the comic is reliable?
 - Can we trust his information? Why or why not?
 - Are there facts that are true in the comic?
 - Are the conclusions drawn from the facts valid?
 - Are there claims that are not supported by evidence?

- 6 Discuss the role of scientists and scientific information in society, for example, science has led to changes in the way people live. Discuss how scientists' findings can influence personal and community choices, and the importance of how they are interpreted.
- 7 Discuss how it is important for scientists not only to find new evidence and test theories, but also to effectively communicate what they find so that people in the community can make informed decisions.
- 8 Explain that students are going to create multimedia texts and/or presentations to communicate what they have learned during the unit to members of the community. Discuss different multimedia presentations they could develop, for example, posters, oral presentations with visual slides, websites or flyers.
- 9 Describe the features you will be looking for to assess the quality of students' reports:
 - well-organised information
 - clear, concise communication
 - evidence of knowledge of the topic
 - use of evidence and reasoning to support claims
 - quality of the presentation/text.
- 10 Provide students with time to plan, prepare and publish their texts or present their presentations.
Optional: Organise for members of the community to observe students' texts and presentations.
- 11 Display the enlarged copy of 'Certificate of Appreciation' (Resource sheet 14) in the classroom.

Australian Curriculum links

Science

- Ask a scientist to talk to the class about their work informing community and personal decisions, for example, an environmental scientist who conducts environmental impact assessments.

English

- Ask students to write and illustrate their own short comic.
- Critically analyse texts to determine their veracity. Use a variety of texts on the same topic. Include recounts/reports from newspapers, science magazines and the internet. Students then determine criteria for considering the reliability of the text, for example, source type, author/reporter, depth of data, tone of language, bibliography, well-supported claims, illustration type and clarity.



Successful conclusion of the investigation

Dear Live Wires

We have excellent news! Electric Boy was able to apprehend Professor Pitch-black and Short Circuit. They are now in custody awaiting trial at the Super Court.



We thank you again for your support during this investigation. We could not have done it without you. We enclose this Certificate of Appreciation to recognise your contribution to the case. We trust that the information you have investigated for us will help inform decisions in your community.

While examining their lair to find evidence for the trial we uncovered the enclosed comic strip that Short Circuit had written to justify his actions. We thought you might be interested to see his reasoning.

Once again, we thank you for your collaboration with us. We appreciate your diligent gathering of evidence, the use of other scientific investigation skills and your determination to reach informed conclusions.

Sincere salutations
Ima Constable
Chief Investigator, STIVS

Certificate of appreciation

Certificate of Appreciation

This certificate is awarded to

In recognition of your scientific investigation skills which enabled us to avert a serious situation.



Ima Constable
Chief Investigator, STIVS

Propaganda for Short Circuit

 <p>SHORT CIRCUIT Saves the world!</p>	<p>Once upon a time there was an ordinary teenager</p>  <p>Nothing about special me...</p>	<p>But then one day...</p>  <p>EGAD! washing machine hot water pump electric oven electric stoves electric heaters television computer</p> <p>WE USE SO MUCH ELECTRICAL ENERGY!</p>	 <p>He conceived a brilliant plan...</p>
 <p>WHAT A WASTE!</p> <p>We should use energy carefully!</p>	 <p>GAS! POLLUTION!</p> <p>He saw serious impacts on the environment...</p>		



Appendix 1

How to organise collaborative learning teams (Year 3–Year 6)

Introduction

Students working in collaborative teams is a key feature of the PrimaryConnections inquiry-based program. By working in collaborative teams students are able to:

- communicate and compare their ideas with one another
- build on one another's ideas
- discuss and debate these ideas
- revise and rethink their reasoning
- present their final team understanding through multi-modal representations.

Opportunities for working in collaborative learning teams are highlighted throughout the unit. Students need to be taught how to work collaboratively. They need to work together regularly to develop effective group learning skills.

Team structure

The first step towards teaching students to work collaboratively is to organise the team composition, roles and skills. Use the following ideas when planning collaborative learning with your class:

- Assign students to teams rather than allowing them to choose partners.
- Vary the composition of each team. Give students opportunities to work with others who might be of a different ability level, gender or cultural background.
- Keep teams together for two or more lessons so that students have enough time to learn to work together successfully.
- If you cannot divide the students in your class into teams of three, form two teams of two students rather than one team of four. It is difficult for students to work together effectively in larger groups.
- Keep a record of the students who have worked together as a team so that by the end of the year each student has worked with as many others as possible.

Team roles

Students are assigned roles within their team (see below). Each team member has a specific role but all members share leadership responsibilities. Each member is accountable for the performance of the team and should be able to explain how the team obtained its results. Students must therefore be concerned with the performance of all team members. It is important to rotate team jobs each time a team works together so that all students have an opportunity to perform different roles.

For Year 3–Year 6, the teams consist of three students — Director, Manager and Speaker (for F–Year 2, teams consist of two students — Manager and Speaker). Each member of the team should wear something that identifies them as belonging to that role, for example, a wristband, badge or colour-coded peg. This makes it easier for you to identify which role each student is doing and it is easier for the students to remember what they and their team mates should be doing.

Manager

The Manager is responsible for collecting and returning the team's equipment. The Manager also tells the teacher if any equipment is damaged or broken. All team members are responsible for clearing up after an activity and getting the equipment ready to return to the equipment table.

Speaker

The Speaker is responsible for asking the teacher or another team's Speaker for help. If the team cannot resolve a question or decide how to follow a procedure, the Speaker is the only person who may leave the team and seek help. The Speaker shares any information they obtain with team members. The teacher may speak to all team members, not just to the Speaker. The Speaker is not the only person who reports to the class; each team member should be able to report on the team's results.

Director

The Director is responsible for making sure that the team understands the team investigation and helps team members focus on each step. The Director is also responsible for offering encouragement and support. When the team has finished, the Director helps team members check that they have accomplished the investigation successfully. The Director provides guidance but is not the team leader.

Team skills

Primary**Connections** focuses on social skills that will help students work in collaborative teams and communicate more effectively.

Students will practise the following team skills throughout the year:

- move into your teams quickly and quietly
- speak softly
- stay with your team
- take turns
- perform your role.

To help reinforce these skills, display enlarged copies of the team skills chart (see the end of this Appendix) in a prominent place in the classroom.

The development of these team skills aligns to descriptions in the Australian Curriculum: English. See page 7.



Supporting equity

In science lessons, there can be a tendency for boys to manipulate materials and girls to record results. Primary**Connections** tries to avoid traditional social stereotyping by encouraging all students, irrespective of their gender, to maximise their learning potential. Collaborative learning encourages each student to participate in all aspects of team activities, including handling the equipment and taking intellectual risks.

Observe students when they are working in their collaborative teams and ensure that both girls and boys are participating in the hands-on activities.

TEAM SKILLS

- 1 Move into your teams quickly and quietly**
- 2 Speak softly**
- 3 Stay with your team**
- 4 Take turns**
- 5 Perform your role**

TEAM ROLES

Manager

Collects and returns all materials the team needs

Speaker

Asks the teacher and other team speakers for help

Director

Makes sure that the team understands the team investigation and completes each step

Appendix 2

How to use a science journal

Introduction

A science journal is a record of observations, experiences and reflections. It contains a series of dated, chronological entries. It can include written text, drawings, labelled diagrams, photographs, tables and graphs.

Using a science journal provides an opportunity for students to be engaged in a real science situation as they keep a record of their observations, ideas and thoughts about science activities. Students can use their science journals as a useful self-assessment tool as they reflect on their learning and how their ideas have changed and developed during a unit.

Monitoring students' journals allows you to identify students' alternative conceptions, find evidence of students' learning and plan future learning activities in science and literacy.

Using a science journal

- 1** At the start of the year, or before starting a science unit, provide each student with a notebook or exercise book for their science journal or use an electronic format. Tailor the type of journal to fit the needs of your classroom. Explain to students that they will use their journals to keep a record of their observations, ideas and thoughts about science activities. Emphasise the importance of including pictorial representations as well as written entries.
- 2** Use a large project book or A3 paper to make a class science journal. This can be used at all stages to model journal entries. With younger students, the class science journal can be used more frequently than individual journals and can take the place of individual journals.
- 3** Make time to use the science journal. Provide opportunities for students to plan procedures and record predictions, and their reasons for predictions, before an activity. Use the journal to record observations during an activity and reflect afterwards, including comparing ideas and findings with initial predictions and reasons. It is important to encourage students to provide evidence that supports their ideas, reasons and reflections.
- 4** Provide guidelines in the form of questions and headings, and facilitate discussion about recording strategies, for example, note-making, lists, tables and concept maps. Use the class science journal to show students how they can modify and improve their recording strategies.
- 5** Science journal entries can include narrative, poetry and prose as students represent their ideas in a range of styles and forms.
- 6** In science journal work, you can refer students to display charts, pictures, diagrams, word walls and phrases about the topic displayed around the classroom. Revisit and revise this material during the unit. Explore the vocabulary, visual texts and ideas that have developed from the science unit, and encourage students to use them in their science journals.

- 7 Combine the use of resource sheets with journal entries. After students have pasted their completed resource sheets in their journal, they might like to add their own drawings and reflections.
- 8 Use the science journal to assess student learning in both science and literacy. For example, during the *Engage* phase, use journal entries for diagnostic assessment as you determine students' prior knowledge.
- 9 Discuss the importance of entries in the science journal during the *Explain* and *Evaluate* phases. Demonstrate how the information in the journal will help students develop literacy products, such as posters, brochures, letters and oral or written presentations.

Essential energy science journal entry

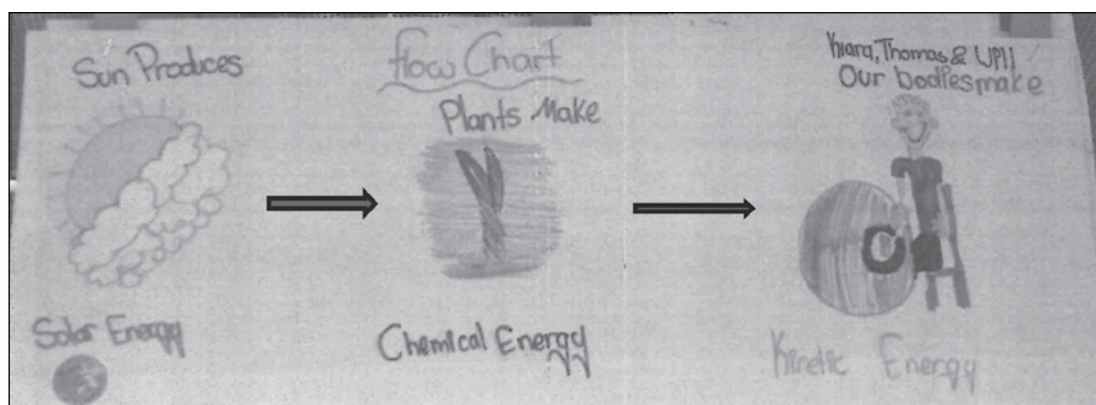

Work sample of a flow chart

Appendix 3

How to use a word wall

Introduction

A word wall is an organised collection of words and images displayed in the classroom. It supports the development of vocabulary related to a particular topic and provides a reference for students. The content of the word wall can be words that students see, hear and use in their reading, writing, speaking, listening and viewing.

Goals in using a word wall

A word wall can be used to:

- support science and literacy experiences of reading, viewing, writing and speaking
- provide support for students during literacy activities across all key learning areas
- promote independence in students as they develop their literacy skills
- provide a visual representation to help students see patterns in words and decode them
- develop a growing bank of words that students can spell, read and/or use in writing tasks
- provide ongoing support for the various levels of academic ability in the class
- teach the strategy of using word sources as a real-life strategy.

Organisation

Position the word wall so that students have easy access to the words. They need to be able to see, remove and return word cards to the wall. A classroom could have one main word wall and two or three smaller ones, each with a different focus, for example, high-frequency words.

Choose robust material for the word cards. Write or type words on cardboard and perhaps laminate them. Consider covering the wall with felt-type material and backing each word card with a self-adhesive dot to make it easy for students to remove and replace word cards.

Word walls do not need to be confined to a wall. Use a portable wall, display screen, shower curtain or window curtain. Consider a cardboard shape that fits with the unit, for example, an apple for a needs unit.

The purpose is for students to be exposed to a print-rich environment that supports their science and literacy experiences.

Organise the words on the wall in a variety of ways. Place them alphabetically, or put them in word groups or groups suggested by the unit topic, for example, words for an *Essential energy* unit might be organised using headings, such as 'Types of energy' and 'Uses of energy'.

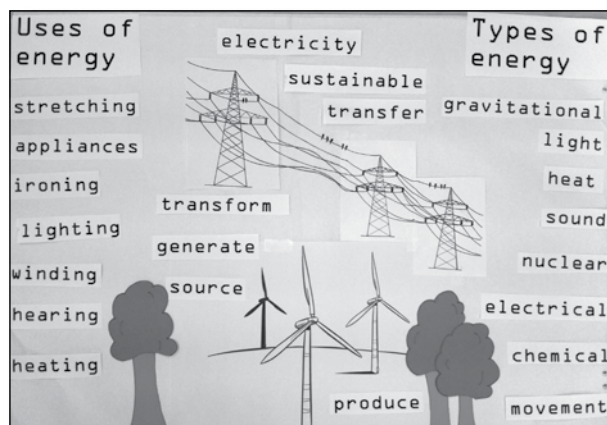

Essential energy word wall

Using a word wall

- 1 Limit the number of words to those needed to support the science and literacy experiences in the classroom.
- 2 Add words gradually, and include images where possible, such as drawings, diagrams or photographs. Build up the number of words on the word wall as students are introduced to the scientific vocabulary of the unit.
- 3 Encourage students to interact with the word wall. Practise using the words with students by reading them and playing word games. Refer to the words during science and literacy experiences, and direct students to the wall when they need a word for writing. Encourage students to use the word wall to spell words correctly.
- 4 Use the word wall with the whole class, small groups and individually during literacy experiences. Organise multi-level activities to cater for the individual needs of students.

Science chat-board

One way of recording students' learning journey throughout the unit is to use a science chat-board as a TWLH chart. This is a space where students record thoughts, ideas, questions, claims, evidence and reasoning as the unit progresses.

A separate 'Our questions' section is created on the science chat-board to ensure all students' questions are captured, and a 'Word wall' section is provided for students to record relevant words and associated images.

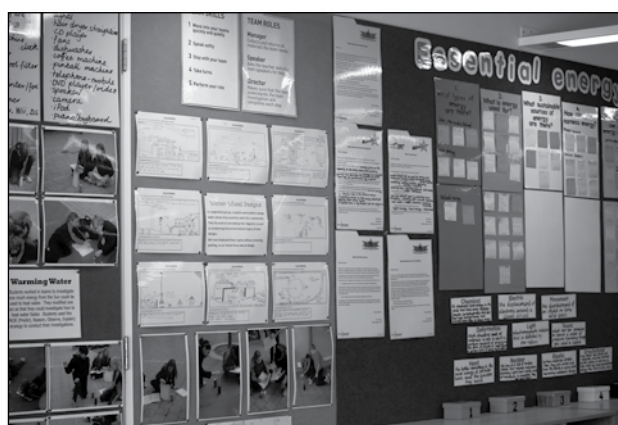

Essential energy chat-board

Appendix 4

How to use a glossary

Introduction

A glossary is a list of technical terms that relate to a particular subject matter or topic, generally accompanying a document. Each term is accompanied by a description or explanation of the term within the context of the subject. A glossary entry is generally more descriptive than a dictionary definition.

Creating a class glossary can be used to:

- elicit students' prior understanding of subject-specific terms
- develop a growing bank of descriptions to help students understand and use new words in written and oral tasks
- support students' understanding of scientific descriptions and explanations
- develop the strategy of using word sources as a real-life, valuable investigative research strategy.

Using a class glossary

- 1** Introduce a term and discuss what it might mean within the context of the unit. Possible strategies include students connecting the word to a feature or aspect of the topic, and students using the word in a spoken sentence to explain topic, concept or context.
- 2** Create a shared understanding of the term, and record it in the science journal or as part of the word wall.
- 3** Introduce the conventional technical meaning of the term where appropriate.
- 4** Encourage students to practise using the terms in the glossary to become familiar with them. Students may wish to amend a description of a word after becoming more familiar with how it is used in a particular context. This may occur when writing, talking or making annotations to diagrams.
- 5** Integrate the glossary across all curriculum areas where appropriate. For example, in a literacy lesson discuss various meanings for the term.
- 6** The glossary could be a part of the science journal or the word wall for a particular unit.

Note: It is important to ask students for 'descriptions' of the terms rather than 'definitions'. 'Definitions' are often viewed as fixed and unchangeable, whereas 'descriptions' support students to see that ideas can change as their understanding develops.

Appendix 5

How to facilitate evidence-based discussions

Introduction

Argumentation is at the heart of what scientists do — they pose questions, make claims, collect evidence, debate with other scientists and compare their ideas with others in the field.

In the primary science classroom, argumentation is about students:

- articulating and communicating their thinking and understanding to others
- sharing information and insights
- presenting their ideas and evidence
- receiving feedback (and giving feedback to others)
- finding flaws in their own and others' reasoning
- reflecting on how their ideas have changed.

It is through articulating, communicating and debating their ideas and arguments that students are able to develop a deep understanding of science content.

Establish norms

Introduce norms before starting a science discussion activity. For example:

- listen when others speak
- ask questions of each other
- criticise ideas not people
- listen to and discuss all ideas before selecting one.

Claim, evidence and reasoning

In science, arguments that make claims are supported by evidence. Sophisticated arguments follow the QCER process:

- Q** What **question** are you trying to answer? For example, 'What happens to the speed at which the weight is lifted when we change the number of blades?'
- C** The **claim**, for example, 'When we increase the number of blades, the weight is lifted faster'.
- E** The **evidence**, for example, 'We performed a fair test on a simple windmill. When it had three blades it lifted the weight in an average of 20s, and when it had four blades it lifted the weight in an average of 15s. This test was repeated several times to account for possible experimental errors'.
- R** The **reasoning** — saying how the evidence supports the claim, for example, 'Since the only thing that changed in the test was the number of blades, the decrease in lifting time is due to the increased number of blades'.

Students need to be encouraged to move from making claims only to citing evidence to support their claims. Older students develop full conclusions that include a claim, evidence and reasoning. This is an important characteristic of the nature of science and an aspect of scientific literacy. Using science question starters (see next section) helps to promote evidence-based discussion in the classroom.

Science question starters

Science question starters can be used to model the way to discuss a claim and evidence for students. Teachers encourage team members to ask these questions of each other when preparing their claim and evidence. They might also be used by audience members when a team is presenting its results (see *PrimaryConnections 5Es* DVD, Chapter 5).

Science question starters

Question type	Question starter
Asking for evidence	I have a question about _____ . How does your evidence support your claim _____ ? What other evidence do you have to support your claim _____ ?
Agreeing	I agree with _____ because _____.
Disagreeing	I disagree with _____ because _____. One difference between my idea and yours is _____.
Questioning further	I wonder what would happen if _____ ? I have a question about _____ . I wonder why _____ ? What caused _____ ? How would it be different if _____ ? What do you think will happen if _____ ?
Clarifying	I'm not sure what you meant there. Could you explain your thinking to me again?

Appendix 6

How to conduct a fair test

Introduction

Scientific investigations involve posing questions, testing predictions, planning and conducting tests, interpreting and representing evidence, drawing conclusions and communicating findings.

Planning a fair test

In *Essential energy*, students investigate things that affect the amount of electricity generated by the battery.

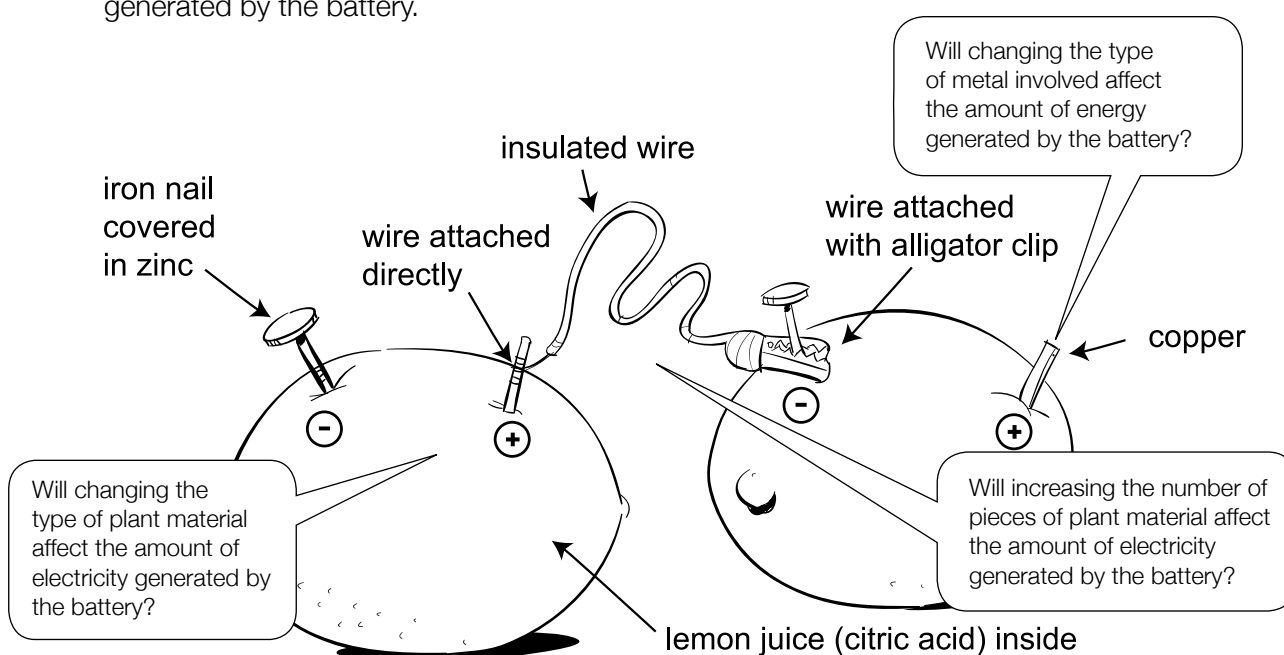

All scientific investigations involve variables. Variables are things that can be changed (independent), measured/observed (dependent) or kept the same (controlled) in an investigation. When planning an investigation, to make it a fair test, we need to identify the variables.

It is only by conducting a fair test that students can be sure that what they have changed in their investigation has affected what is being measured/observed.

'Cows Moo Softly' is a useful scaffold to remind students how to plan a fair test:

Cows: **Change** one thing (independent variable)

Moo: **Measure/observe** another thing (dependent variable) and

Softly: Keep the other things (controlled variables) the **same**.

To investigate things that affect the amount of electricity generated by the battery, students could:

CHANGE	the type of plant material	Independent variable
MEASURE/ OBSERVE	the volts/the brightness of the LED light	Dependent variable
KEEP THE SAME	the number of pieces of plant material, the type of metal used, the amount of metal, the temperature of the plant material, the temperature of the room.	Controlled variables

Q2 What happens to the amount of energy generated by a battery when we change the type of metal used?

In this question, **the amount of energy generated by a battery** depends on **the type of metal used**.

The type of metal used is the thing that is **changed** (independent variable) and **the amount of energy generated by the battery** is the thing that is **measured or observed** (dependent variable).

Developing questions for investigation

The process of developing questions for investigation is to:

- Provide a context and reason for investigating.
- Pose a general focus question in the form of: ‘What things might affect _____ (**dependent variable**)?’
 - For example, ‘What things might affect the amount of energy generated by a battery?’
 - Use questioning to elicit the things (independent variables) students think might affect the dependent variable, for example, the type of plant material, the number of pieces of plant material, the type of metal used, the amount of metal, the temperature of the plant material, the temperature of the room.

Each of the **independent variables** can be developed into a question for investigation. These are the things that might be changed (**independent variables**), which students think will affect the thing that is measured or observed (**dependent variable**).

- Use the scaffold ‘What happens to _____ when we change _____?’ to help students develop specific questions for their investigation. For example, ‘What happens to the amount of energy generated by a battery when we change the type of plant material used?’
- Ask students to review their question for investigation after they have conducted their investigation, and collected and analysed their information.

Encouraging students to review their question will help them to understand the relationship between what was changed and what was measured in their investigation. It also helps students to see how the information they collected relates to their prediction.

Appendix 8

How to construct and use a graph

Year 6

Introduction

A graph organises, represents and summarises information so that patterns and relationships can be identified. Understanding the conventions of constructing and using graphs is an important aspect of scientific literacy.

During a scientific investigation, observations and measurements are made, and measurements are usually recorded in a table. Graphs can be used to organise the data to identify patterns, which help answer the research question and communicate findings from the investigation.

Once you have decided to construct a graph, two decisions need to be made:

- What type of graph?
- Which variable goes on each axis of the graph?

What type of graph?

The Australian Curriculum: Mathematics describes data representation and interpretation for Year 6 as follows:

- Interpret and compare a range of data displays, including side-by-side column graphs for two categorical variables (ACMSP147).
- Interpret secondary data presented in digital media and elsewhere (ACMSP148).

Column graph

Where data for one of the variables are in **categories** (that is, we use **words** to describe it, for example, earthquake location), a **column graph** is used.

Graph A below shows how the results of an investigation of the effect of material type on the amount of light that passes through it (**data in categories**) have been constructed as a **column graph**.

Table A: The effect of material on the amount of light that passes through

Material	Amount of light
plastic sheet	all
bubble wrap	almost all
tissue paper	most
paper	not much
cardboard	none
foil	none

Graph A: The effect of material on the amount of light that passes through

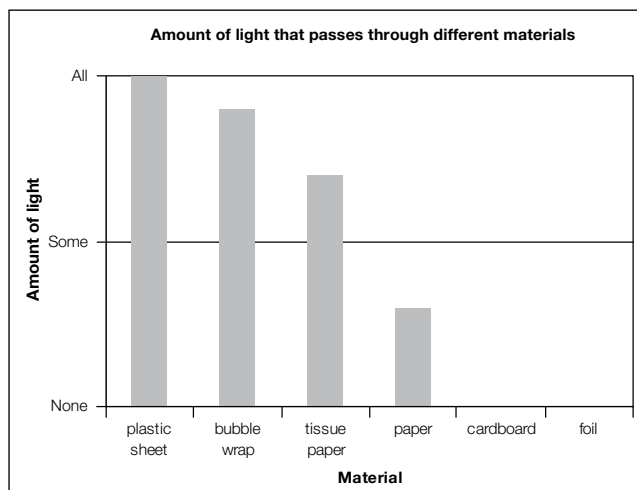

Which variable goes on each axis?

It is conventional in science to plot the variable that has been changed on the horizontal axis (X axis) and the variable that has been measured/observed on the vertical axis (Y axis) of the graph.

Graph titles and labels

Graphs have titles and each variable is labelled on the graph axes, including the units of measurement. The title of the graph is usually in the form of 'The effect of one variable on the other variable'. For example, 'The effect of material on the amount of light that passes through'.

Steps in analysing and interpreting data

Step 1 – Organise the data (for example, construct a graph) so you can see the pattern in data or the relationship between data for the variables (things that we change, measure/observe, or keep the same).

Step 2 – Identify and describe the pattern or relationship in the data.

Step 3 – Explain the pattern or relationship using science concepts.

Questioning for analysis

Teachers use effective questioning to assist students to develop skills in interrogating and analysing data represented in graphs. For example:

- What is the story of your graph?
- Do the data in your graph reveal any patterns?
- Is this what you expected? Why?
- Can you explain the pattern? Why did this happen?
- What do you think the pattern would be if you continued the line of the graph?
- How certain are you of your results?

Analysis

Analysis of Graph A shows that the amount of light that passes through materials changes according to the type of material. This is because the more transparent or translucent a material is, the more light can pass through it.

Appendix 9 Essential Energy equipment list

EQUIPMENT ITEM	QUANTITIES	Lesson		1	2	2	3	4	4	5	6	7	8
		1	2										
Equipment and materials													
AA batteries	2 per class												
A3 paper (or butcher's paper)	12 sheets per class	•											
adhesive tape	1 per team	•											
adhesive tac	2 pieces per team												
bucket	1 per class												
cans (soft drink) — empty	2 per team												
cans ('Types of energy') A4 or half A4	11 per class												
clipboard (optional)	1 per team			•									
container (eg, yoghurt, ice-cream)	1 per class												
copper	2 pieces per team												
equipment for modifying cans (see 'Preparation')	Assortment per team												
folder (eg, manila folder)	1 per student												
light globe, small	1 per class												
lemon or potato	2 per team												
letter-writing materials	1 per class or per team												
marking pens	6 per class or 1 per team	•											
materials for waterwheel blades	8 pieces per team												
materials for modifying battery (see 'Preparation')	1 set per team												
measuring cup	1 per class												
nails, galvanised	2 per team												
pen	1 per team												
resource materials containing definition of energy	At least one per class												

EQUIPMENT ITEM	QUANTITIES	Lesson		2		3		4		5		6		7		8	
		1	Session	1	2	1	2	1	2	1	2	1	2	1	2	1	2
resources multimedia	1 set per class																
sand or marbles (to fill container)	Per class																
scissors or Stanley knife	1 per class																
self-adhesive notes	5 per student	•															
shoe-boxes or similar	5 per class	•															
skewers (wooden)	8 per team																
stopwatch or watch with a second hand	1 per class																
string	2 x 30 cm pieces per team																
thermometer	1 per team																
voltmeter or small LED light globe with two wires	1 per team																
water	1 bucket per class																
waterwheels from Lesson 4, Session 1	Per team																
weight (small)	1 per team																
wire, insulated with alligator clips	3 pieces per team or 2 pieces per class																
Resource sheets																	
'Request for scientific support' (RS1), enlarged	1 per class	•															
'School energy survey' (RS2)	1 per team																
'School energy survey' (RS2), enlarged	1 per class																
'Information note for families' (RS3)	1 per student																
'Auditing appliances' (RS4)	1 per student																
'Auditing appliances' (RS4), enlarged	1 per class																
'Auditing appliances' (RS4), completed	1 per student																
'Energy usage guide' (see 'Preparation')	1 per student																
'PROE' (RS5)	1 per team																
'PROE' (RS5), enlarged	1 per class																

EQUIPMENT ITEM	QUANTITIES	Lesson		1		2		3		4		5		6		7		8	
		Session		1	2	1	2	1	2	1	2	1	2	1	2	1	2	1	2
'Waterwheel procedure' (RS6)	1 per team																		
'Waterwheel procedure' (RS6), enlarged	1 per class																		
'Waterwheel investigation planner' (RS7)	1 per team																		
'Waterwheel investigation planner' (RS7), enlarged	1 per class																		
'Where does electrical energy come from?' (RS8)	1 per team																		
'Where does electrical energy come from?' (RS8), enlarged	1 per class																		
'Measuring mayhem' (RS9)	1 per student																		
'Measuring mayhem' (RS9), enlarged	1 per class																		
'Generating electricity' (RS10), enlarged	1 per class																		
'Battery procedure' (RS11)	1 per team																		
'Battery procedure' (RS11), enlarged	1 per class																		
'Battery investigation planner' (RS12)	1 per team																		
'Battery investigation planner' (RS12), enlarged	1 per class																		
'Successful conclusion' (RS13), enlarged	1 per class																		
'Certificate of appreciation' (RS14), enlarged	1 per class																		
'Propaganda for Short Circuit' (RS15)	1 per student																		
'Propaganda for Short Circuit' (RS15), enlarged	1 per class																		
Teaching tools																			
class science journal	1 per class																		
word wall, science chat-board	1 per class																		
student science journal	1 per student																		
team roles chart	1 per class																		
team skills chart	1 per class																		
role wristbands or badges	1 set per team																		

Appendix 10 Essential Energy unit overview

LESSON SUMMARY		LESSON OUTCOMES*	ASSESSMENT OPPORTUNITIES
ENGAGE	<p>Lesson 1 Scientific support</p> <p>Students</p> <ul style="list-style-type: none"> discuss what they think they know about energy and what electrical energy is used for share ideas using a think-box strategy record ideas on the science chat-board. 	<p>Students will be able to</p> <p>represent their current understandings as they:</p> <ul style="list-style-type: none"> discuss different types of energy and how the types of energy could be transformed or transferred contribute to discussions about electricity, how it is used and how it is produced identify the purpose and features of a science journal, word wall and chat-board work in teams to sort and classify ideas pose questions for investigation in response to a request for assistance. 	<p>Diagnostic assessment</p> <ul style="list-style-type: none"> Science journal entries Class discussions Science chat-board and word wall Think-boxes
	<p>Lesson 2 Susceptible to shortages</p> <ul style="list-style-type: none"> explore the different types of energy identified by scientists observe the different types of energy used in their school identify how household machines transform one type of energy into another explore electrical energy usage in and around the home. 	<ul style="list-style-type: none"> identify different types of energy work in collaborative learning teams to observe different types of energy in the school record their observations in a table discuss and compare their observations explore and document electricity use in their home. 	<p>Formative assessment</p> <ul style="list-style-type: none"> Science journal entries Class discussions Science chat-board and word wall Tables 'School energy survey' (Resource sheet 2) 'Auditing appliances' (Resource sheet 2) Glossaries
EXPLORE			

* These outcomes are aligned with relevant descriptions of the Australian Curriculum: Science and are provided at the beginning of each lesson.

LESSON SUMMARY		LESSON OUTCOMES*	ASSESSMENT OPPORTUNITIES
EXPLORE	<p>Students</p> <ul style="list-style-type: none"> work in collaborative learning teams to investigate how energy from the Sun can be used to heat water modify a soft drink can to investigate how to heat the water faster. 	<p>Students will be able to</p> <ul style="list-style-type: none"> identify that heat from the Sun can be transferred to heat water use a PROE strategy to plan a simple investigation work in collaborative learning teams to safely investigate methods of improving the heating of water in a can record observations in a table compare their results with their predictions, and present to the class evaluate their investigation discuss the advantages and disadvantages of different methods of heating water. 	<p>Formative assessment</p> <ul style="list-style-type: none"> Science journal entries Class and discussions Science chat-board and word wall Tables Oral presentations 'PROE' (Resource sheet 5)
	<p>Lesson 3 Here comes the Sun</p>		

* These outcomes are aligned with relevant descriptions of the Australian Curriculum: Science and are provided at the beginning of each lesson.

LESSON SUMMARY		LESSON OUTCOMES*		ASSESSMENT OPPORTUNITIES	
<p>Students</p> <ul style="list-style-type: none"> • work in collaborative learning teams to create a waterwheel • identify one variable to change on their waterwheel • work in collaborative learning teams to test their changed waterwheel • discuss and compare their results. 	<p>Students will be able to</p> <ul style="list-style-type: none"> • write a question for investigation and predict what will happen when the variable that they chose changes • work in collaborative learning teams to plan and safely conduct an investigation about variables that affect the efficiency of a waterwheel • record results of multiple trials in a table and calculate averages • make evidence-based claims about their results and compare their results with their predictions and with other teams' results • evaluate their investigation • identify how waterwheels transfer and transform energy and have been used by different cultures for centuries • discuss the management challenges and environmental impacts of harnessing energy from streams and rivers. 		<p>Formative assessment</p> <ul style="list-style-type: none"> • Science journal entries • Class discussions • Science chat-board and word wall • Tables • 'Waterwheel investigation planner' (Resource sheet 7) 		
EXPLORE					
<p>Lesson 4 Mobilising movement</p>					

* These outcomes are aligned with relevant descriptions of the Australian Curriculum: Science and are provided at the beginning of each lesson.

LESSON SUMMARY		LESSON OUTCOMES*		ASSESSMENT OPPORTUNITIES
	Students	Students will be able to		
Lesson 5 Domestic help	<ul style="list-style-type: none"> • create flow charts to show energy transformations and transfers • read and discuss factual texts about how to generate electricity • compare the benefits of different energy sources. 	<ul style="list-style-type: none"> • draw flow charts representing energy transfer and transformation • make claims about where energy may come from • read and interpret factual texts • contribute to discussions about how electricity is generated. 	<p>Formative assessment</p> <ul style="list-style-type: none"> • Science journal entries • Class discussions • Science word wall and chat-board • Flow charts 	
Lesson 6 Necessary energy	<ul style="list-style-type: none"> • present the results of their investigations about the use of appliances • identify what electricity is used for in households and how it is used. 	<ul style="list-style-type: none"> • identify how electricity is used in the home • contribute to discussions about how often different appliances are used and whether they are necessary • participate in creating a factual letter including evidence-based claims. 	<p>Formative assessment</p> <ul style="list-style-type: none"> • Science journal entries • Class discussions • Science word wall and chat-board • 'Measuring mayhem' (Resource sheet 9) • Letter-writing 	

* These outcomes are aligned with relevant descriptions of the Australian Curriculum: Science and are provided at the beginning of each lesson.

LESSON SUMMARY		LESSON OUTCOMES*		ASSESSMENT OPPORTUNITIES
	Students	Students will be able to		
ELABORATE	<p>Lesson 7 Full of potential</p> <ul style="list-style-type: none"> • make a simple battery following a procedural text • work in collaborative learning teams to plan and conduct an investigation to determine the effect of a chosen variable on the functioning of their battery • observe, record and share the results of their investigation. 	<ul style="list-style-type: none"> • write a question for investigation and predict what will happen when a variable is changed • work in collaborative learning teams to plan and safely conduct an investigation about variables that affect a simple battery • record their results in a table • make evidence-based claims about their results • compare their results with their predictions and with other teams' results • evaluate their investigation • discuss and compare this method of electricity production with other methods. 	<p>Summative assessment of Science Inquiry Skills</p> <ul style="list-style-type: none"> • Science journal entries • Class and group discussions • Science word wall and chat-board • Tables • 'Battery investigation planner' (Resource sheet 12) 	
	<p>Lesson 8 Community choices</p> <ul style="list-style-type: none"> • review and reflect on their learning during the unit • read and discuss a propaganda text • discuss the role of scientists and scientific information in society • create texts to communicate what they have learned. 	<ul style="list-style-type: none"> • discuss a propaganda text and assess its scientific claims • identify that science and culture interact to influence personal and community choices • create multimedia texts and/or presentations to communicate what they have learned during the unit, supporting claims with evidence • contribute to discussions and express their opinions about their learning journey. 	<p>Summative assessment of Science Understanding</p> <ul style="list-style-type: none"> • Science journal entries • Class discussions • Science word wall and chat-board • Multimedia texts 	

* These outcomes are aligned with relevant descriptions of the Australian Curriculum: Science and are provided at the beginning of each lesson.



Professional learning

PrimaryConnections: linking science with literacy is an innovative program linking the teaching of science with the teaching of literacy in primary schools. The program includes a professional learning component and curriculum units aligned to the Australian Curriculum: Science.

Research has shown that the professional learning component of the **PrimaryConnections** program significantly enhances the implementation of the curriculum units. Professional Learning Facilitators are available throughout Australia to conduct a variety of workshops. At the heart of the professional learning program is the Curriculum Leader Training Program.

PrimaryConnections Curriculum Leader Training Program

Held annually, this two-day workshop develops a comprehensive understanding of the **PrimaryConnections** program. Participants receive professional learning resources that can be used to train others in **PrimaryConnections**.

PrimaryConnections one-day Introduction to PrimaryConnections Program

This workshop develops knowledge and understanding of **PrimaryConnections**, and the benefits to enhance the teaching and learning of science and literacy.

The professional learning calendar, other workshops and booking forms can be found on the website: www.science.org.au/primaryconnections

Order your next unit at
www.science.org.au/primaryconnections

Year	Biological sciences	Chemical sciences	Earth and space sciences	Physical sciences
F	<i>Staying alive</i>	<i>What's it made of?</i>	<i>Weather in my world</i>	<i>On the move</i>
1	<i>Schoolyard safari</i>	<i>Spot the difference</i>	<i>Up, down and all around</i>	<i>Look! Listen!</i>
2	<i>Watch it grow!</i>	<i>All mixed up</i>	<i>Water works</i>	<i>Push pull</i>
3	<i>Feathers, fur or leaves?</i>	<i>Melting moments</i>	<i>Night and day</i>	<i>Heating up</i>
4	<i>Plants in action</i>	<i>Material world</i>	<i>Beneath our feet</i>	<i>Smooth moves</i>
	<i>Friends and foes</i>	<i>Package it better</i>		
5	<i>Desert survivors</i>	<i>What's the matter?</i>	<i>Earth's place in space</i>	<i>Light shows</i>
6	<i>Marvellous micro-organisms</i>	<i>Change detectives</i>	<i>Earthquake explorers</i>	<i>It's electrifying</i>
				<i>Essential energy</i>

PrimaryConnections: Linking science with literacy is an innovative program linking the teaching of science with the teaching of literacy in primary schools.

The program combines a sophisticated professional learning program with exemplary curriculum resources.

PrimaryConnections features an inquiry-based approach, embedded assessment and incorporates Indigenous perspectives.

The **PrimaryConnections** curriculum resources span Years F–6 of primary school.

www.science.org.au/primaryconnections

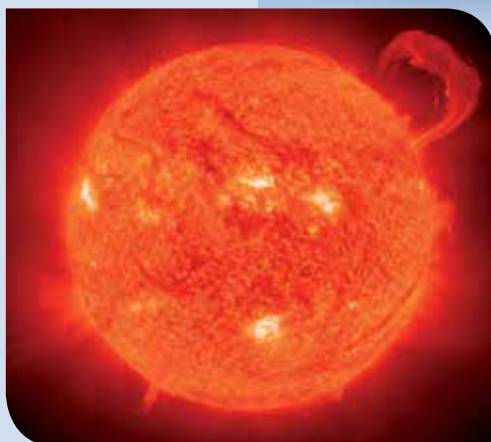

Australian Government

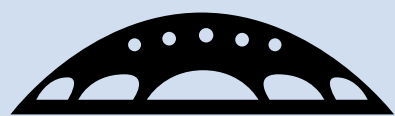

Australian Academy of Science